



ILLINOIS HEALS

Helping Everyone Access
Linked Systems

ACTION PLAN

ILLINOIS HELPING EVERYONE ACCESS LINKED SYSTEMS ACTION PLAN

June 2019

Prepared by

Jaclyn Houston-Kolnik, Ph.D., Senior Research Analyst
Megan Alderden, Ph.D., Acting Executive Director
Reshma Desai, MSW, Project Director
Amanda L. Vasquez, M.A., Research Analyst
Paola Baldo, M.A., M.Ed., Research Analyst
Jason Wynkoop, M.A., LCSW, Project Coordinator
Soeun Tiffany Kim, B.S, Graduate Social Work Intern

This document was supported by Grant #2017-VF-GX-K002, awarded by the U.S. Department of Justice Office of Justice Programs' Office for Victims of Crime. The opinions, findings and conclusions, or recommendations expressed in this document are those of the contributors and do not necessarily represent the official position of the U.S. Department of Justice.

Suggested citation: Houston-Kolnik, J., Alderden, M., Desai, R., Vasquez, A. L., Baldo, P., Wynkoop, J & Kim, S. T. (2019). *Illinois HEALS: Helping Everyone Access Linked Systems Action Plan*. Chicago, IL: Illinois Criminal Justice Information Authority.

ACKNOWLEDGEMENTS

The Authority wishes to thank the following individuals and agencies for providing assistance and guidance for this project:

A special thank you to our Leadership Network for their continued commitment and guidance.

We are deeply grateful to each and every young adult and caregiver who shared their stories with us and thank them for their recommendations on how we can better serve those impacted by violence. We are humbled by their strength and willingness to talk with us so openly about their experiences.

We are also thankful for all the service providers, practitioners, and community members who generously lent their time and expertise to share their experiences working with children, youth, and their families. We recognize their passion and dedication to meeting every opportunity and striving to help clients and their communities succeed.

We appreciate the guidance, support and encouragement of our grant monitor at the Office for Victims of Crime, Bethany Case, and our training and technical assistance liaison, Wendy Schiller and her colleagues at the National Council of Juvenile and Family Court Judges.

We would like to acknowledge all ICJIA staff who helped review and finalize this document.

TABLE OF CONTENTS

Illinois Helping Everyone Access Linked Systems.....	01
Project Background.....	02
Vision, Mission & Values.....	03
Project Scope.....	04
What We've Done.....	05
Leadership Network.....	06
Stakeholder Meetings.....	07
Direct Service Provider Surveys.....	07
Victim Interviews.....	07
What We've Learned.....	08
A Relational Approach to Strong Linkages.....	10
Recognize.....	11
Connect.....	14
Engage.....	16
Project Goals.....	19
Goal 1.....	21
Goal 2.....	23
Goal 3.....	25
Goal 4.....	27
Goal 5.....	30
Goal 6.....	34
Endnotes.....	35
Appendices.....	37
Appendix A: Leadership Network.....	38
Appendix B: Cook County Juvenile Justice Maps.....	39
Appendix C: Meetings Thematic Analysis.....	59
Appendix D: Direct Service Provider Surveys.....	66
Appendix E: Victim Interviews.....	77
Appendix F: Time-Task Plan.....	78

**ILLINOIS HELPING EVERYONE
ACCESS LINKED SYSTEMS**

PROJECT BACKGROUND

In October 2017, the Illinois Criminal Justice Information Authority was awarded a Linking Systems of Care for Children and Youth Demonstration grant from the Office for Victims of Crime (OVC), Office of Justice Programs, U.S. Department of Justice.[1] The demonstration project seeks to address the needs of child and youth victims[2] and their families[3] by identifying young crime victims, coordinating prevention and intervention services post-victimization, and building capacity within communities to provide needed services and support.

Titled [Illinois Helping Everyone Access Linked Systems \(Illinois HEALS\)](#), this six-year initiative brings together experts, service providers, community groups, young victims and their families, and other stakeholders to:

- Complete a 15-month strategic planning process resulting in a detailed action plan.
- Implement strategies that promote the identification, connection, and service engagement of children, youth, and families impacted by violence in Illinois.
- Identify and support sustainable approaches and programs that build service capacity within communities.
- Document project activities, including barriers, challenges, and successes, to help inform expansion to other communities in Illinois.



VISION, MISSION & VALUES

Informed by the objectives and principles outlined by OVC, Illinois HEALS adopted the following vision, mission, and values to guide the activities proposed in this action plan.

Vision. Alleviate the burden of finding services to address victimization by ensuring appropriate care and services are made available to all victims no matter whose door they first enter, whether it is their doctor's office, their school, or the local police station or sheriff's office.

Mission. Illinois HEALS leverages federal, state, and community resources and partnerships to implement policies, practices, and programs that strengthen the capacity of Illinois' communities to recognize when victimization has occurred and connect and engage young victims and families in needed services.

Values. Six core principles guide the strategic planning and implementation efforts.

Principle 1 - Healing individuals, families, and communities (OVC Guiding Principle): Individuals and families who experience or have been exposed to violence deserve support for healing. Healing includes safety, justice, the opportunity to make positive social-emotional connections, and self-determination. Opportunities for healing occur at all points of contact; healing interventions are accessible, trauma-informed, strength-based, individualized, and gender- and culturally responsive. [4]

Principle 2 - Linked systems of care (OVC Guiding Principle): All systems of care are connected and aspire to maximize collective impact through communication, collaboration, and coordination.[5]

Principle 3 - Informed decision making (OVC Guiding Principle): Linked Systems of Care provide as much information as possible to families and practitioners so that the most targeted, holistic, safe, and effective interventions are available.[6]

Principle 4 - Respect for persons (Illinois-specific Guiding Principle): All victims deserve access to appropriate and effective support services, and those who have experienced victimization know their needs best. The agency of each person should be acknowledged and valued, and victims should be partners in developing their treatment plans.

Principle 5 - Respect for families (Illinois-specific Guiding Principle): Families are vital to the health and well-being of children and youth; services and support should consider and be made available to family members, enabling the entire family to heal.

Principle 6 - Respect for communities (Illinois-specific Guiding Principle): Communities also play an important role in the health and well-being of individuals and families. Any initiative seeking to enact change within a community, should be led by those who work or live in that community and build upon existing community assets and strengths.

PROJECT SCOPE

Illinois HEALS seeks to improve responses to victimization experienced from birth to young adulthood by strengthening the coordination of support services available through linking several systems of care.

Types of victimization. Children and youth can experience various types of victimization in their homes, schools, and communities. The Illinois HEALS initiative seeks to address both direct experiences and indirect exposure to victimization. Direct experiences may include assault and battery; sexual assault; firearm violence; emotional, physical, psychological, or sexual abuse; neglect; bullying; dating violence; and domestic violence. Indirect exposure includes witnessing or learning about the victimization of others.

Age at time of victimization. Victimization can occur throughout a young person's life, and the type, frequency, and impact can vary depending on a young person's stage of development. The Illinois HEALS initiative has adopted an expanded definition of young persons to comprise of anyone whose victimization experiences, whether direct or indirect, occurred during infancy and up to 25 years of age. This more inclusive definition was chosen because research indicates that young persons are at heightened risk for violent victimization, particularly during key developmental "turning points" (e.g., adolescence, young adulthood).[7] Moreover, over the past decade, a consensus has emerged that cognitive and social development is still occurring at a rapid pace for individuals in their early 20s. Trauma resulting from victimization can interrupt or alter ongoing developmental processes; providing further support that emerging adults impacted by violence could benefit from additional supports.[8]

Systems. Young persons and their families encounter many different systems. These systems or domains include: child welfare, civil and family court, community-based services, education, integrated health, and justice. Each system has its own language, culture, and purpose. Although these systems periodically come together to address issues of concern, they often operate in a siloed manner that impedes access to needed services for victims of crime. Illinois HEALS seeks to reduce the barriers and harm young victims and their families may face when disclosing their experiences to or accessing services with systems-based providers by creating a coordinated, multi-system approach to victim identification, referral, and service.

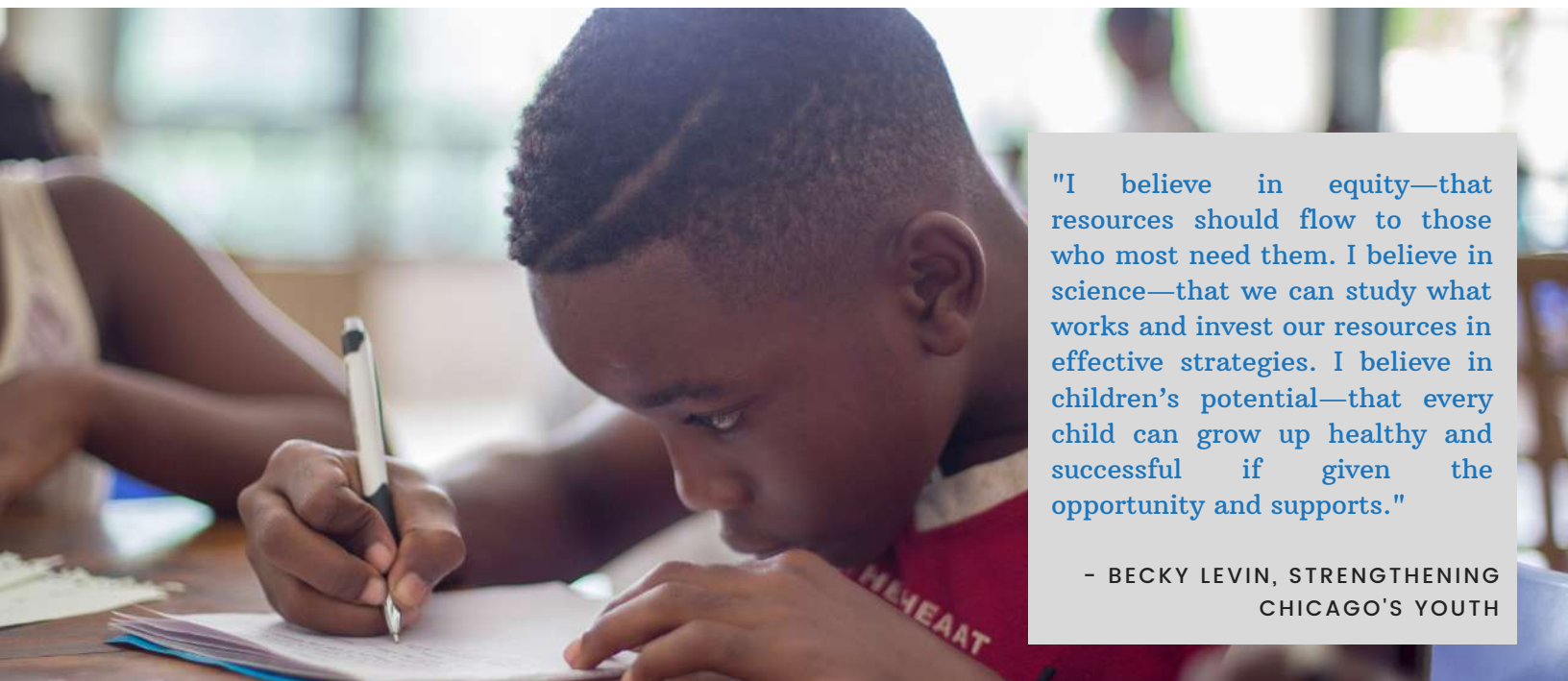

"I believe in equity—that resources should flow to those who most need them. I believe in science—that we can study what works and invest our resources in effective strategies. I believe in children's potential—that every child can grow up healthy and successful if given the opportunity and supports."

- BECKY LEVIN, STRENGTHENING CHICAGO'S YOUTH

WHAT WE'VE DONE

In January 2018, Illinois HEALS staff began having in-depth conversations across Illinois with other state agencies, system partners, community stakeholders, providers, young victims impacted by violence, and their families. Through these conversations we sought to learn:

- Victim need, how providers and systems in Illinois responded to victimization, and victim recommendations for improving these responses.
- Provider and practitioner perspectives on identifying and responding to victims.
- Current capacity of systems across the state to identify, refer, and support victims.
- Past and current initiatives in Illinois that involve(d) cross-system collaboration or focus(ed) on child and youth victims.

LEADERSHIP NETWORK

The Illinois HEALS Leadership Network consists of stakeholders across the many systems that engage children, youth, and families including child welfare, civil and family court, community-based services, education, integrated health, and justice. The Leadership Network was convened quarterly during the planning phase to share emergent findings, brainstorm opportunities and barriers to the work, and identify other individuals and organizations whose input could further inform the project. A list of our Leadership Network can be found in *Appendix A*.

The Leadership Network had its inaugural meeting in April 2018; approximately 50 key leaders and stakeholders from across the state attended. They discussed the potential for Illinois HEALS to assist in improving responses to children, youth, and their families; existing practices and opportunities that could be leveraged; barriers to cross-system collaborations, such as fractured community-based infrastructure; issues of provider capacity; major transitions in coordinated care systems like Medicaid; and overburdened agencies and systems. Additionally, those who are finding success in navigating these issues shared unique solutions to inform others facing similar challenges.

Dr. David Finkelhor, director of the Crimes against Children Research Center at the University of New Hampshire, presented his research on the victimization experiences of children and youth. Dr. Finkelhor highlighted the complexity of multiple victimizations and how children and youth often are exposed to multiple types of violence. He emphasized several crucial points, including:

- Victim need, how providers and systems in Illinois responded to victimization, and victim recommendations for improving these responses.
- Provider and practitioner perspectives on identifying and responding to victims.
- Current capacity of systems across the state to identify, refer, and support victims.
- Past and current initiatives in Illinois that involve(d) cross-system collaboration or focus(ed) on child and youth victims.

Drawing from this presentation and feedback from the Leadership Network, the Illinois HEALS project was narrowed to focus on three domains—education, integrated health, and justice. Education and integrated health serve as primary touchpoints for children and youth during key transition years. Youth who experience high rates of violent victimization often come into contact with the justice system.

The project also was geographically narrowed. Illinois is a large state where community characteristics, victimization rates, and service availability differ across regions. It became apparent that Illinois HEALS staff needed to engage local communities in a more focused way. Staff identified four community areas based on victimization rates, stakeholder input, and county population characteristics. These areas included counties in and around the Second Judicial Circuit, located in the state's southeastern region, south suburban Cook County municipalities just south of Chicago, and two neighborhoods within Chicago—Englewood and North Lawndale.

Leadership Network meetings focused on updating stakeholders on key planning work findings, including the initial results of a survey of direct service providers in Illinois and victim interviews (both discussed below). During these meetings, Leadership Network stakeholders provided valuable feedback to further shape and inform the action plan. In October 2018, the Leadership Network participated in multiple breakout groups designed to gather information and feedback about three elements of the Illinois HEALS action plan framework: multi-disciplinary approaches to service delivery, trauma-informed training, and service availability. Groups identified effective models and trainings that have been implemented in Illinois and elsewhere, discussed what made these initiatives successful, and provided insight into core assets and resources needed.

STAKEHOLDER MEETINGS

Illinois HEALS staff convened over 45 meetings with key stakeholders, with a focus on Cook County and the southeastern region of the state. Staff sought to understand how children, youth, and families in Illinois who have been impacted by victimization are identified, referred, and served. The meetings generally centered on the processes used to identify victimization and signs of underlying trauma, challenges and barriers in service delivery, and the nature and scope of program referral and collaboration networks. Some meetings involved a process-mapping exercise to identify how children and youth are routed through systems and potentially linked to resources. For instance, the “maps” were used to document the various ways in which children and youth interact with various parts of the criminal justice system (*Appendix B*).

Meeting notes, audio recordings, and transcripts from the meetings were collected for systematic analysis. More information about overarching themes that emerged from these meetings can be found in *Appendix C*.

DIRECT SERVICE PROVIDER SURVEYS

Researchers conducted a direct service provider survey to gain an understanding of the services and processes of agencies and programs that serve children, youth, and their families and provide insight into the service landscape in Illinois. The survey intended to reach every organization providing services in Illinois, ranging from advocacy and material assistance to treatment (e.g., physical, psychological, substance use), case management, and other supports. The survey collected information about when and how providers identify victimization, provide or receive referrals, and collaborate with other agencies. The survey asked about the range of available services from these agencies. The survey also asked participants to provide general program information such as client population, service areas, funding source(s), and staff composition. One hundred and eighty-four unique agencies and programs serving children, youth, and families in Illinois participated in the direct service provider survey. More information about the agencies who participated and other results from the survey are available in *Appendix D*.

VICTIM INTERVIEWS

The Linking Systems of Care: Young Adults and Caregivers Study was conducted via interviews with young adults aged 18 to 25 years old and parents or caregivers of children and youth under 18 years old who were impacted by violence in Illinois ($N = 65$). The interviews focused on youth and family member needs following experiences with victimization, the systems youth and family members had contact with, and how well those systems met their needs. The interviews asked young adults and family members for recommendations on how to improve and equip providers and systems they work within to better identify and address victimization. More information and initial findings are available in *Appendix E*.

WHAT WE'VE LEARNED

A significant number of children and youth in Illinois are exposed to violence in their homes, schools, and communities. Some experience multiple forms of victimization and exposure that contribute to more complex trauma symptoms. In 2017 alone, there were 120,828 reports of child abuse and neglect (25 percent of which were indicated) and 7,743 reports of child sexual abuse (25 percent of which were indicated) reported to the Illinois Department of Children and Family Services;[9] 12,424 children and youth were served by Child Advocacy Centers;[10] 54,771 reports of violent index crimes reported to Illinois police agencies, including 984 murders and 5,330 sexual assaults;[11] and 115,362 domestic offenses reported to law enforcement.[12], [13] Additionally, a Center for Disease Control national study (2017) found that 21 percent of Illinois high school students stated they were bullied on school property and 17 percent said they were electronically bullied.[14]

CHILDHOOD VICTIMIZATION: DIRECT & POSSIBLE EXPOSURE, 2017

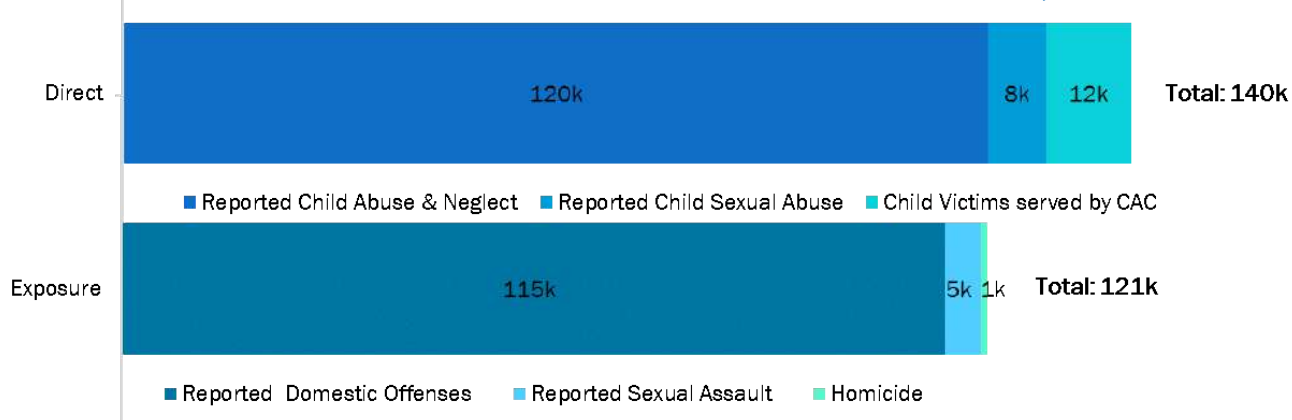

Source: Illinois Department of Children and Family Services; Child Advocacy Centers of Illinois; Illinois Uniform Crime Reporting Data

Note: Data on direct victims may include duplicate victims; Data for possible exposure are not a count of children who have been exposed, but of reported incidents where children and youth may be exposed to the impact of a crime.

The sheer numbers alone, however, do not speak to the profound impact both direct and indirect exposure to victimization can have on children, youth, families, and communities. Victimization experiences can cause post-traumatic stress disorder, depression, and anxiety;[15] negatively impact healthy development and decrease academic achievement;[16] and increase future victimization risk.[17] Access to linked services that address these mental, physical, and developmental consequences of violence often is necessary for healing of young victims and families. Conversations with stakeholders throughout the state and reviews of past initiatives and research revealed the essential components for strong linkages: learning that someone is a victim of a crime and assessing what the victim needs, exploring who could provide needed services and then making a referral, and addressing the needs of victims through services.

Discussions with stakeholders, providers, and practitioners highlighted challenges and opportunities to creating strong linkages across systems serving young victims and families in Illinois. The capacity of systems to engage in early identification and swift service linkage has been negatively impacted by years of state budgetary crises and consequent financial problems in Illinois. Some existing systems of care and referral networks, including mental health agencies and other organizations that offer support services for victims, have reduced services or closed their doors. This issue is further complicated by the fact that Illinois is an incredibly diverse state, not only as it relates to the racial and ethnic composition of its residents, but to the population density of its communities, languages spoken, rates of poverty, child and youth violence exposure, and service availability. Inadequate funding coupled with the diversity of the state have limited the success of past attempts at improving access to services, particularly in rural communities and urban neighborhoods of color.

Although these challenges exist, so do opportunities. Conversations with stakeholders throughout the state have revealed there is great interest in cross-system collaboration and strengthening the screening, referral networks, and services available for young victims and their families. Interviews with victims demonstrate that many victims are ready to work alongside providers and practitioners to engage their communities in building strong linkages.

While identification, referral, and support are core to creating strong linkages, stakeholders and victims discussed relationships as essential for these three components to function in a meaningful way. Victims emphasized that a meaningful response is centered in relationships founded on trust and respect. Providers discussed how relationships with systems and agencies built upon accountability and resource sharing were crucial to comprehensively serving clients whose needs often extended beyond their own capacity. Viewing these essential components through the lens of relationship, strong linkages involve recognizing victimization has occurred and assessing its impact, connecting victims to needed resources, and providing services that meaningfully engage victims and their families.

A RELATIONAL APPROACHES TO LINKAGES

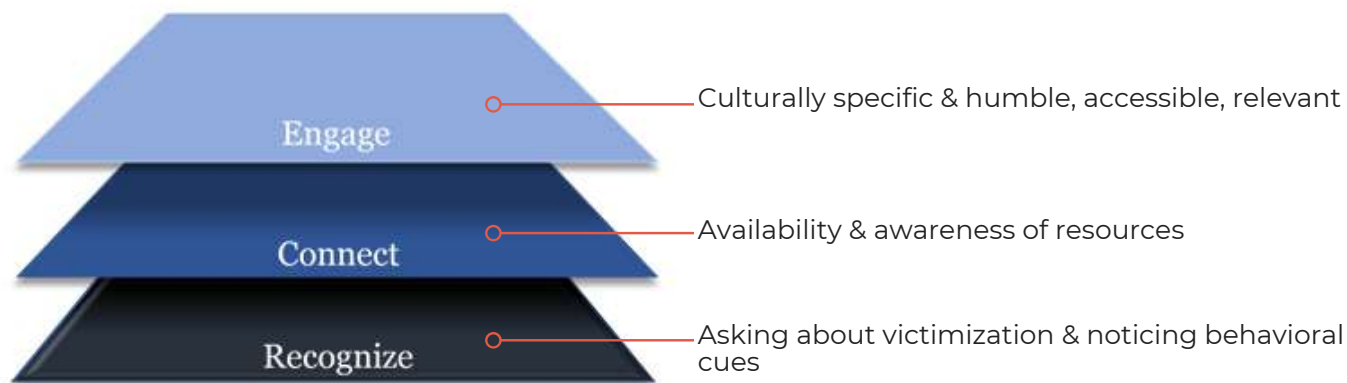

The next sections highlight key components identified during the Illinois HEALS project planning phase: recognizing victimization, connecting individuals with resources, and engaging support services. The sections discuss the importance of each component, the aspiration for Illinois, and a summary of what is currently happening in communities.

"I believe that we have never experienced the full power of human potential because of the burden of violence, oppression, and trauma. I believe I can help release that amazing energy and change the world."

- MARLITA WHITE, CHICAGO DEPARTMENT OF PUBLIC HEALTH



RECOGNIZE

Recognizing children and youth experiences with violence means becoming attuned to the varied ways in which victims express and cope with victimization. Relying on victims to disclose their experiences overlooks other ways in which adults can recognize something is wrong, such as through other verbal and behavioral cues[18] or a child's physical appearance or affect. These indicators can be a launching point for further follow up to better understand the nature and extent of victimization, its impacts, and the need for intervention.



ASPIRATION

To recognize verbal, non-verbal, or behavioral indicators of victimization children and youth may exhibit, [community members, stakeholders, and providers should be trained to understand how victimization may present](#), such as through internalizing behaviors (symptoms of anxiety disorder, major depressive disorder, post-traumatic stress disorder [PTSD]), externalizing behaviors (symptoms of oppositional defiant disorder, conduct disorder), trauma symptomology,[19] or feelings of anger and blame. [Adults interacting with young persons also should be educated about helpful and harmful responses](#) to victimization disclosures. Additionally, it is critical for organizations to provide [clear policies and protocols that support staff in implementing self-care practices](#) because hearing about others' violent victimization experiences can be traumatic.[20]



CURRENT STATUS

Conversations with system practitioners revealed that numerous different screening tools are used in Illinois to identify victimization and trauma experiences. Many of these tools are used after individuals are already heavily involved with a system. Formal, [consistent screening for prior and current victimization is more likely to occur “deeper” within systems](#), such as when a youth is sentenced to probation or corrections, and less so during earlier points in time such as during routine medical interactions, at arrest, or upon school admission. When victimization is identified during these earlier interactions, oftentimes providers noted it is at the discretion of the practitioner to ask or the result of disclosure by victims or their family members.

Despite some screening and assessment occurring, many providers reported their tools often do not include victimization-specific questions. However, many providers believe in the importance of early recognition. They said more training and clear, established protocols are needed to help staff recognize when harm or victimization has occurred, as [many practitioners do not feel sufficiently equipped to talk with young victims and families about](#)

these experiences. Although some trainings on approaches to engaging young persons are available, providers are seeking training opportunities that will equip them with the skills necessary to hold these conversations in a trauma-informed way. Nevertheless, the existence of these trainings suggests that organizations are primed and eager to build capacity and promote systems change.

Some stakeholders noted recognizing victimization is more than just asking questions; they said practitioners need training on common non-verbal and behavioral cues that may indicate current or past victimization. Similarly, stakeholders and providers identified the need for training and educational campaigns for community members about trauma that de-normalize violence and encourage help-seeking.

Victims and providers continually emphasized the importance of rapport building to create safe and judgement-free environments that facilitate the identification of victimization experiences. Victims shared how opportunities to recognize harm often are missed without a trusting relationship. Trusting and respectful relationships can facilitate meaningful and successful recognition of harm, whether through informal ad hoc conversations or more formalized screening and assessment. In fact, when asked how providers can learn whether someone has experienced harm, victims cited the respect and patience needed to build trusting relationships.

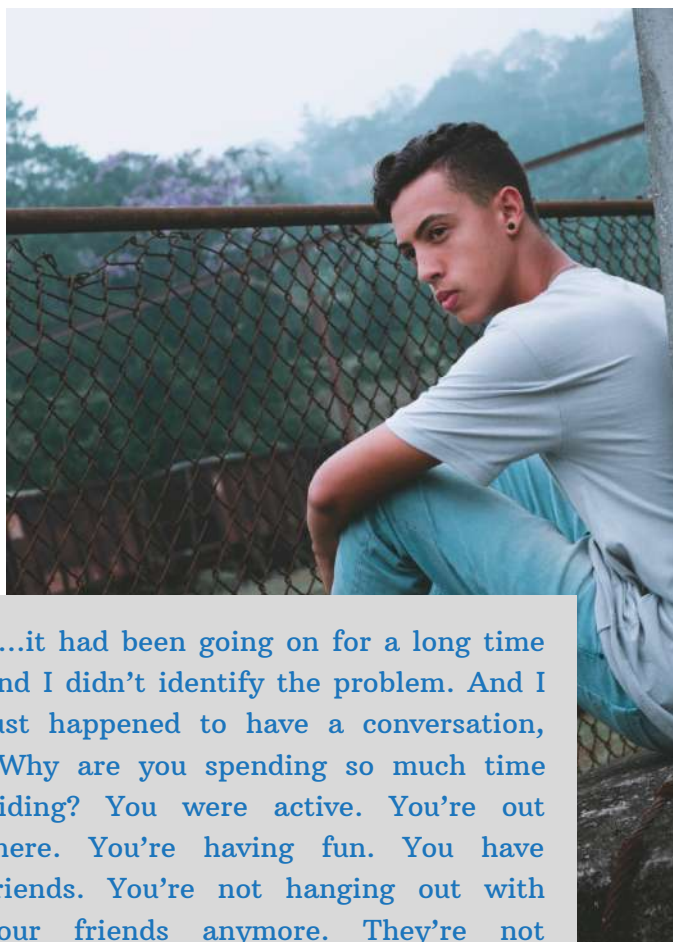

“...it had been going on for a long time and I didn’t identify the problem. And I just happened to have a conversation, “Why are you spending so much time hiding? You were active. You’re out there. You’re having fun. You have friends. You’re not hanging out with your friends anymore. They’re not coming by the house to visit you.”

- CAREGIVER, PARTICIPANT 265

Victims asserted that providers do not prioritize rapport building and trust and providers acknowledged the inability of many systems to do so with the clients they serve. Faced with limited resources, high caseloads, and workforce instability, providers expressed that the time needed to build relationships often is unavailable. That said, some systems inherently facilitate the development of strong, positive relationships between young persons and adults. Victims pointed to schools as one key intervention point because of the positive relationships that many have had with teachers, coaches, school counselors, and social workers. In settings such as schools where practitioners also serve as mandated reporters, however, providers shared their reluctance to reporting suspicions of abuse and neglect because it may be perceived as a breach of trust.

Oftentimes, practitioners do not know if services exist or they are available due to waitlists or eligibility criteria. Some practitioners within the integrated health domain expressed

concern about implementing screening practices. Both a lack of services and inadequate information about the availability of services has created an ethical dilemma in which practitioners felt uneasy about implementing screening protocols to identify victimization when services to address victimization-related needs may not exist or are unavailable. From their perspective, knowing what resources are accessible is critical.

Although providers acknowledged the potential for vicarious trauma and the need for self-care, they said actualizing self-care in practice is challenging. A handful of provider organizations said they have created purposeful spaces for staff to decompress, debrief, and reflect; these organizations, however, were in the minority. For many, [the desire to help others in crisis coupled with budgetary constraints \(and in some cases funding policies\) leaves limited room for self-care activities](#). Providers from some systems described atmospheres where new staff face significant caseloads and stress that ultimately contributes to high turnover rates. Administrators reported this dynamic is exacerbated by the lack of a skilled workforce prepared to deliver the myriad of services some clients need. In addition, low wages make it difficult to recruit and retain more experienced staff.



CONNECT

Violence impacts multiple facets of victims' lives, such as their physical and emotional well-being and professional and personal relationships. To address these impacts, individuals often must interact with numerous systems and providers to access needed services. The burden of seeking help often is placed on the victim and they encounter frequent barriers to successfully connecting to services. Many victims may be unaware if services exist, what services would meet their needs, or whether these services are accessible (e.g., language, transportation, and waitlist barriers).[21]



ASPIRATION

Strong, meaningful connections require establishing networks that promote information sharing and coordination to facilitate access to services that address client needs. Simply providing information about services has been less successful at connecting victims to services than more active methods.[22] More active approaches to making connections could include a case manager accompanying a client to another provider or one provider coordinating with another to schedule an appointment and arrange transportation (a common barrier to accessing services). These connections place the burden on providers, instead of victims, to navigate multiple systems. Institutionalizing these connections in systems of care or multidisciplinary approaches place the burden on providers, instead of victims, to navigate multiple systems.



CURRENT STATUS

Both victims and their family members and practitioners reported they could not always confidently locate or access services. For many victims, doctors and law enforcement were the only providers they readily knew how to connect with and often these providers could not be relied upon to actively connect them to other providers or to simply offer informational resources when victimization was recognized. Practitioners reported having similar issues amongst themselves, due to a lack of knowledge or awareness about what services were available or if local providers were operating at or above capacity.

A lack of information sharing within and across systems is a barrier to ensuring meaningful connections that are timely and appropriate. Without knowledge of the services available in a community and who is eligible for such services, providers were unable to make meaningful connections or made referrals to services for which a client was ineligible, a potentially distressing and devaluing experience. A lack of information sharing impeded the ability of providers to know whether referrals resulted in services or additional follow-up with a client was needed. The lack of communication and information sharing fostered distrust between different agencies and systems.

The process of navigating the current disjointed service system landscape was frustrating for both victims and providers. Providers often learned about agencies closing or being at capacity from their clients who were unable to access services. They felt the lack of communication and unsuccessful referrals contributed to client disengagement. While some victims were resourceful, relying upon the internet and their informal social networks to assist them in making connections to needed care, many victims wanted a provider to take on the burden of navigating a confusing and overwhelming array of systems and services. The frustration experienced by victims was exacerbated by unnecessary screening and assessment resulting from a lack of information sharing and cross-agency accountability.

“When we were with [Program] working on services and still hitting some walls, but making some progress. But when we got [navigator] involved...all the doors opened.”

- CAREGIVER, PARTICIPANT 313

Connecting clients with services also may be challenging when providers recognize that a client may need some services, but their symptoms or needs may not rise to the level that necessitates extensive treatment or meets criteria for formal diagnosis. Unfortunately, in these circumstances, some treatments do not qualify for funding, and providers find the issue difficult to navigate. Diagnosing a client may allow him or her to subsequently access needed care, but doing so also poses ethical dilemmas for providers.



ENGAGE

Many young victims and their family members enter systems and the doors of service providers with a multitude of needs. Some have experienced several forms of victimization.[23] With few exceptions, all have current or past experiences interacting with at least one system (e.g., healthcare, schools), and others are involved with many (e.g., justice, child welfare, civil/family court). For some, these experiences have been positive. For others, these interactions have fostered distrust, making engagement in services more challenging.



ASPIRATION

Strong engagement means services and supports that reach young persons and their families, actively meet clients where they are at, and prioritize what is most important to the victim.[24] Strengthening engagement necessitates a shift from services being driven by what is available in the community to what a client identifies as his or her needs. It also includes incorporating the needs of other family members.

Identification of needs and [appropriate services begin with proper assessment, followed by case planning that is developed around victim goals](#) and gives clients the flexibility to choose not only the services they perceive to be essential to their healing, but the right provider for them. [Services that address fundamental needs, such as food, employment, or housing, may enable clients to engage in services](#) by removing barriers and building trust and rapport.[25] To further ease access, services could be offered in spaces where children, youth, and their families regularly interact, such as child care agencies, schools, and healthcare settings. Additionally, providers may explore promising methods to access services not readily available in the community, such as mobile units and tele-health or tele-psychiatry.

At the organizational level, cultural humility trainings and the development and implementation of policies that promote cultural humility are critical. Cultural humility is not simply knowledge or awareness of other cultures, but an approach that is self-reflective, respectful, open, and fosters learning about how culture may shape someone's experiences. [26] [Community characteristics and the culture of the individual should be considered](#) in the structure of services and incorporated into training for staff.

[Service providers should also adopt a trauma-informed approach](#), which seeks to create a safe environment where individuals do not experience further trauma or harm while receiving services and support.[27] A trauma-informed approach necessitates care for staff, who may also experience traumatic stress reactions resulting from exposure to another's traumatic experiences, rather than from direct exposure. Vicarious trauma can contribute to burnout and turnover, which can lead to inconsistent and inadequate services, negatively impacting clients. Thus, agencies may benefit from adoption of policies and practices that support an organizational culture shift in which regular supervision, team building exercises, and paid leave are institutionalized for overall well-being and mental health to mitigate the impact of vicarious trauma and maintain a healthy organization.



CURRENT STATUS

During conversations with stakeholders it became apparent that many of the systems that regularly engage children and youth are operating at or over capacity in Illinois. As such, systems and organizations described how they engage in crisis management, adopting a triage approach to services. This approach assists individuals by addressing immediate safety needs; however, [many victims discussed the need for longer-term support and more comprehensive care to heal from their trauma or maintain safety](#). Additionally, this triage approach results in prioritizing certain cases, consequently allowing some to go unaddressed. Some organizations that have tried to navigate this issue reported potential in engaging peer or paraprofessionals who are able to undertake some tasks and responsibilities to free up specialized staff to address more complex victim needs.

For many victims, their most immediate needs were basic, such as food, employment, or housing. Some [victims expressed they were not ready or able to address their experiences with trauma before their fundamental needs were met](#). Some providers reported they could provide support in meeting these immediate needs during the initial crisis, but long-term support often was unavailable or difficult to access. Nevertheless, some providers were successful in building initial rapport with children and youth when they prioritize meeting some of their basic needs.

Both victims and practitioners noted [services typically focus only on the direct victim, and do not consider the impact of victimization on the entire family](#). Family members often prioritize the needs of their children over the impacts that indirect exposure to violence or their own victimization histories have on them. Furthermore, a single provider is not always equipped to meet the needs of both children and adults, creating an additional barrier to engaging the family unit in services.



[“...she helped us find a new place to live...she helped us let the kids have a good Christmas. She just helped us get school supplies cuz money’s tight. Like she’s given us resources, told us where to go get help. And she is amazing.”](#)

- CAREGIVER, PARTICIPANT 241

When discussing recommendations for how to help young victims and their families heal from victimization, victims highlighted the potential of those settings where children and youth interact with trusted adults. For instance, many victims identified schools as natural settings to engage children and youth in services. Both providers and victims who had experience providing or receiving services through school-based or affiliated clinicians or counselors felt that this form of service engagement was not only convenient, but effective.

In certain systems existing policies make service engagement challenging. For instance, because the health system treats individuals through a medical lens, children may need a medical or clinical diagnosis to qualify for fundable treatment. For some families and non-medical practitioners, a formal diagnosis may seem unnecessary or inappropriate for young children and youth. Such practices can create additional barriers to engagement in treatment given the stigma associated with having a formal diagnosis.

Providers and system practitioners alike described issues with staff turnover and burnout that impacted client engagement and service quality. The impact of turnover on victims was recounted by providers who noticed victims frustrated about starting over with new staff. They linked this frustration to client disengagement from services. Similarly, providers expressed the need to rebuild relationships with clients and re-establish trust.

Burnout and vicarious trauma also were concerns for providers who emphasized the need to better support their staff and mitigate the impact of trauma exposure and high caseloads. As noted, some agencies reported they already promote self-care to regulate stress and fatigue resulting from vicarious trauma. Others recognized a consistent need to prioritize care and institutionalize staff well-being.

“People that work in the field...in order to deal with the high level of stress and that type of environment, people just kind of disassociate from their patients and see them, I don’t wanna say like less and less human, but in a way, they become very disengaged from the emotional experience of the patient. Which is protective to them and allows them to be effective at their job, maybe in a medical way and not like in a psycho-social way.”

- YOUNG ADULT, PARTICIPANT 238

PROJECT GOALS

Illinois HEALS will partner with one or more demonstration sites to strengthen those communities' capacities to **recognize** victimization, **connect** individuals with resources, and **engage** children and young persons and their families in support services. The work completed will be community-led and inclusive, relying to the greatest extent possible on the multitude of resources, information, and expertise of those living and working in those communities. Illinois HEALS staff will engage in efforts to ensure that the voices of young victims and their families are heard at the state level which will provide an opportunity for demonstration site successes and challenges to inform state level policies and practices that lead to improved support for children, youth, families, and communities. Staff will engage in active research that assists communities in continually learning and reflecting through an established feedback loop on project progress, goals, and outcomes. Finally, staff will work with the federal technical assistance provider to fulfill the action plan.

The following agency and community capacities were identified as essential building blocks for the demonstration site(s):

- A community-based agency that has successfully convened practitioners from multiple systems and diverse agencies and the capacity to manage state grants.
- A variety of active groups and agencies engaged in work that attends to victimization and its impacts.
- Clear champions with the ability to generate community support and action.
- Willingness to support the participation of various community members, including those with lived experience (e.g., victimization, systems experience).
- Local government is sufficiently stable and capable of addressing residents' basic needs and concerns.

Based on what we have learned over the last 15 months, Illinois HEALS staff will work with key stakeholders and local communities to accomplish these goals:

- Goal 1: Build a local System of Care (SOC)[28] that meets the needs of individuals, families, and communities by convening local coordinating bodies, securing appropriate funding, and developing policies and practices that further the work.
- Goal 2: Strengthen the abilities of systems and communities to recognize child and youth victims by fostering community awareness and appropriate screening practices.
- Goal 3: Shore up how systems and communities connect young victims and their families to appropriate resources and services through a multidisciplinary team (MDT)[29] that supports care coordination and facilitates effective referral processes.
- Goal 4: Promote practices that engage young persons who have experienced victimization and their family members in an array of services that are culturally specific and humble, accessible, and relevant by developing the professional workforce and enhancing service capacity and quality.
- Goal 5: Establish a feedback loop between Illinois HEALS staff and SOC and MDT members through research activities that explore community needs, inform best-practices, monitor progress and processes, and assess the fidelity of project implementation.
- Goal 6: Improve the statewide response to victimization of children and youth by raising awareness of the impact of victimization and influencing the policies and practices of agencies and organizations that work with children, youth, and their families.

The following tables outline the strategies, objectives, and action steps associated with each of these six goals and a time-task plan is available in *Appendix F*.

GOAL 1

Build a local System of Care (SOC) that meets the needs of individuals, families, and communities by convening local coordinating bodies, securing appropriate funding, and developing policies and practices that further the work.

Network: Victims are supported and represented by a coordinating body that guides community efforts to address victimization.

Objective 1

Agencies on the coordinating body represent relevant systems, such as child welfare, education, health, juvenile justice.

Action Steps

1. Identify examples and models of high-functioning systems of care that serve children, youth, and families.
2. Recruit representatives from relevant systems, such as child welfare, education, health, juvenile justice agencies to serve on a coordinating body.
3. Recruit people with lived experience to serve on a coordinating body.
4. Leverage ICJIA's relationships to identify and recruit system of care participants from strategic partners.
5. Facilitate process to create an organizational structure and system of governance that will represent and address the concerns of children, youth, and families.

Objective 2

Agencies on the coordinating body will periodically reflect on policies and practices to troubleshoot issues that limit access to or effectiveness of services are created.

Action Steps

1. Facilitate a process to create a mission, vision, values, and goals that will support the efficient and effective implementation of system of care practices.
2. Facilitate a process to create agreements among the member organizations that identify expectations and responsibilities.
3. Create policies and practices for reviewing progress toward goals and addressing concerns of member organizations and the community.

Financial Sustainability: Resource development is ongoing and supports both direct and indirect services required to deliver care.

Objective 1

The community entity (or entities) best positioned to accept and manage federal grant funds for a pilot community coordinator and care coordination functions is identified.

Action Steps

1. Outline the requirements for receiving funds from ICJIA (including Grant Accountability Act [GATA] pre-qualification) for the community.
2. Assist the community entity with GATA and related requirements.
3. Help develop specific positions necessary to perform system of care functions and carry out intent of demonstration project.

Objective 2

Funding that supports critical activities and the associated costs is identified.

Action Steps

1. Leverage Victim of Crime Act (VOCA) Assistance funds to support allowable activities to the greatest degree possible.
2. Leverage relationships with strategic partners (e.g., state agencies, ICJIA grantees, coalitions) to identify resources to support other aspects of the project.

Trauma Informed Practices: The system of care leads the community in creating a culture that is trauma-informed.

Objective 1

Community-wide training initiative promotes culturally humble, trauma-informed approaches to meeting the needs of individuals, families, and the community.

Action Steps

1. Collaboratively identify and fund cross-system training to build relationships and common culture.
2. Implement community wide training initiative.
3. Create mechanisms that reinforce trainings such as consultation groups and learning collaboratives.

GOAL 2

Strengthen the abilities of systems and communities to **recognize** child and youth victims by fostering community awareness and appropriate screening practices.

Awareness: Community members and stakeholders are aware of signs, symptoms, and impact of victimization.

Objective 1

As part of the community-wide training initiative, community members are trained on victimization and needs of victims and families to reduce stigma and increase comfort addressing issues.

Action Steps

1. Develop training plan by identifying various constituencies in the community (e.g., youth, adults, stakeholders) who could contribute to reduction of stigma and increase support for victims.
2. Provide access to and coordinate implementation of training by identify resources including national experts, appropriate curricula, and funding.

Screening: The community screens children and youth for victimization.

Objective 1

Victimization screening practices for children and youth are mapped.

Action Steps

1. Identify all organizations in the demonstration community that serve children and youth.
2. Design and conduct a survey of organizations to learn about screening practices including behavioral observation, screening tools, and other practices that lead to discovery/disclosure of harm.
3. Create a process map that describes the ways in which children and youth victims are identified.
4. Facilitate process to review practices and suggest changes that will lead to more comprehensive, effective, and efficient screening.

Objective 2

More community based settings that serve children and youth are trained to conduct appropriate screening for victimization.

Action Steps

1. Identify best/promising screening practices for the variety of settings in which children and youth commonly participate.
2. Assist in adapting practices to the role and capacity of the organization.
3. Provide access to and coordinate implementation of training by identifying resources including national experts, appropriate curricula, and funding.

Objective 3

Specific protocols for unique settings (i.e., early childhood or afterschool programs) for responding to screens are created.

Action Steps

1. Identify best/promising practices for responding to screens or concerns that arise in the screening process.
2. Assist in adapting practices to the role and capacity of the organization.
3. Assist in the development of setting specific protocols for responding to screens
4. Provide access to and coordinate implementation of training by identifying resources including national experts, appropriate curricula, and funding.

GOAL 3

Shore up how systems and communities **connect** young victims and their families to appropriate resources and services through a multidisciplinary team (MDT) that supports care coordination and facilitates effective referral processes.

Care Coordination: Stakeholders and professionals are equipped to link victims and families to care.

Objective 1

A Multidisciplinary Care Team that addresses the needs of complex families as identified through the SOC partnerships is established.

Action Steps

1. Identify best practices and core components of high functioning multidisciplinary care teams.
2. Strategize with community to develop membership to ensure access to appropriate resources for the families and providers who serve them.
3. Develop a structure and practices that include expectations and accountability for the multidisciplinary care team.

Objective 2

Protocols for needs assessment and planning that are holistic and victim/family-centered are developed.

Action Steps

1. Identify best/promising practices for family-centered needs assessment that are trauma-sensitive.
2. Assist in adapting practices to the role and capacity of the organization.
3. Provide access to and coordinate implementation of training by identifying resources including national experts, appropriate curricula, and funding.

Objective 3

A Care Coordinator position, that serves as the point of contact for victims and families and ensures connection to care, is created.

Action Steps

1. Identify an organization in which the Care Coordinator function can be housed.
2. Identify best/promising practices of care coordination that can be adapted to the community's needs.
3. Design a structure that includes a primary coordinator/supervisor who is accountable for the function.
4. Support the hiring of a care coordinator.

Objective 4

SOC information sharing practices that encourage seamless connections and reduce potential for re-traumatization are developed.

Action Steps

1. Identify best practices and models for sharing information that protect confidentiality and privacy while promoting effective care.
2. Create community-specific documents, policies, procedures, and practices.
3. Work with research staff to assess fidelity of implementation.

Referral Processes: Processes and systems efficiently link providers to each other and families to the community's resources.

Objective 1

A community service directory and two-way referral mechanism is developed or enhanced so community members, providers and survivors can access support efficiently.

Action Steps

1. Facilitate mapping of available resources to be included in directory.
2. Identify technologies to facilitate referral and connection of clients to resources.
3. Identify resources necessary to update and maintain directory.
4. Develop or enhance directory and two-way referral mechanism.
5. Provide access to training for system users.
6. Develop a way for the public to access information about service availability and options.

GOAL 4

Promote practices that **engage** young persons who have experienced victimization and their family members in an array of services that are culturally specific and humble accessible, and relevant by developing the professional workforce and enhancing service capacity and quality.

Workforce: Recruit, train, and retain a representative and trauma-sensitive workforce to meet the needs of victims, their families, and the community.

Objective 1

Professionals who are representative of the local community are recruited to meet direct service needs.

Action Steps

1. Facilitate conversations with providers to identify the recruitment needs of the community.
2. Identify obstacles recruiting professionals who are representative of the local community to meet direct service needs.
3. Identify promising practices to increase recruitment of professionals representative of the local community to meet direct service needs.
4. Support the recruitment of professionals who are representative of the local community.

Objective 2

As part of a larger training effort, the knowledge and skills of the local community workforce are enhanced through training

Action Steps

1. Identify common training needs of the various professional roles that impact the care of children, youth, and their families.
2. Develop training plan that is in alignment with the comprehensive training goals of the community.
3. Provide access to and coordinate implementation of training by identifying resources including national experts, appropriate curricula, and funding.

Objective 3

A plan to retain skilled professionals in the community to maintain necessary and appropriate services is implemented

Action Steps

1. Facilitate conversations with providers to identify the obstacles to retaining skilled professionals in the community for victim services.
2. Seek information about promising practices for retaining staff in victim services.
3. Facilitate the development of staff retention plan.
4. Assist in the implementation of staff retention plan.

Objective 4

Organizations are equipped to care for staff well-being and address vicarious trauma.

Action Steps

1. Identify needs (e.g., training, support, resources) through outreach to organizations and using the SOC coordinating group.
2. Facilitate supportive relationships between organizations that encourage organizations to identify opportunities to work collectively to address needs when appropriate.
3. Provide access to and coordinate implementation of training by identifying resources including national experts, appropriate curricula, and funding.

Service Capacity: An array of services is available that meets identified needs, is accessible, and allows for victim choice.

Objective 1

Building on information gathered in Action Step 1 of Goal 3 objective 1, and other mapping activities, gaps in the service array where additional services are needed to meet community needs are identified.

Action Steps

1. Assess availability of services for children, youth, and young adults.
2. Assess availability of services for families, caregivers, and other indirect victims.
3. Identify service gaps.

Objective 2

Current services and supports are expanded or enhanced which increases choice, promotes engagement, and supports victim and family empowerment.

Action Steps

1. Enhance care options to meet needs across the continuum of care and allow for victim choice.
2. Leverage VOCA Assistance Funds to support and fund service models that increase access and availability of services and encourage engagement of victims and families (i.e., paid peer professionals, mobile services, telehealth)
3. Support community in identifying additional sources of revenue to enhance services and supports.

Quality: Services are evidence-informed, relying on strategies shown to promote healing and relate to victims' needs.

Objective 1

The use of evidence-informed practices in the community is expanded.

Action Steps

1. Identify evidence-informed prevention and intervention activities that could be used to meet the needs of children and youth in the community.
2. Provide access to and coordinate implementation of training on evidence informed practices by identifying resources including national experts, appropriate curricula, and funding.

GOAL 5

Establish a feedback loop between Illinois HEALS staff and SOC and MDT members through research activities that explore community needs, inform best-practices, monitor progress and processes, and assess the fidelity of project implementation.

Community Specific Gap Analysis: Demonstration sites are aware of the needs of victims in their community and the gaps that exist between victim need, service availability, and current training practices.

Objective 1

The needs of victims in the community are identified.

Action Steps

1. Review the needs identified through victim interviews conducted during the planning phase with the community.
2. Revise and add additional needs that victims, service providers, and stakeholders in the community identify.

Objective 2

Gaps in service availability are identified.

Action Steps

1. Assist in designing a community resource mapping activity.
2. Co-conduct resource mapping.
3. Help identify gaps between the needs identified and the resources available in the community.

Objective 3

The training needs of providers interacting with and caring for children, youth, and families are identified.

Action Steps

1. Assist in the development of a survey to assess community awareness of the signs, symptoms, and the impact of victimization.
2. Help administer survey before and after training to assess changes in attitudes, knowledge, awareness, and behaviors to identify additional training needs.
3. Search for trainings that help to address needs identified for service providers.

Best-Practices: Best practices can inform the development and implementation of a SOC project to achieve positive outcomes for victims.

Objective 1

Best practices for informing the development of the SOC are identified

Action Steps

1. Document approaches used to identify funding requirements for community organizations and funding requirements identified.
2. Document approaches used to identify the entity best positioned to accept and manage grants, including the criteria used to select entities, and information about entities selected.
3. Document approaches used to develop care coordination positions and the duties and responsibilities of the position identified as critical for success.
4. Assess fidelity to implementation, including successes and barriers to identifying both funding requirements and the entities positioned to accept and manage grants, and to developing care coordination positions, and the strategies used to overcome those barriers.

Objective 2

Trainings that build the capacity of providers interacting with and caring for children, youth, and families are identified.

Action Steps

1. Document development of training plan, including training needs identified and the resources needed to address those needs.
2. Help design and administer survey before and after training to assess changes in attitudes, knowledge, awareness, and behaviors to assess alignment with best practices.
3. Gather information about training attendance and number of trainings.
4. Document training content and structure through observations of trainings to assess fidelity to training plan.

Objective 3

Best practices of high functioning multidisciplinary teams are identified.

Action Steps

1. Document best practices of high functioning multidisciplinary teams.
2. Document core components of high-functioning multidisciplinary teams.
3. Gather information about attendance at multidisciplinary team meetings.

Objective 4

Best practices for informing the development of programs are identified

Action Steps

1. Gather the research literature and program models for core program activities such as screening, referral, care coordination, prevention, and intervention.
2. Discuss models with the community to explore the appropriateness of various models and explore possible adaptations.
3. Document community perspectives on the strengths and weaknesses of such models.

Project Design: Demonstration sites can adapt best practices for designing, developing, and monitoring an SOC project that capitalizes on the assets of the community and best attends to the needs of children, youth, and families.

Objective 1

A feedback loop between Illinois HEALS staff and SOC and MDT members to align core project components with best practices is established.

Action Steps

1. Document progress of developing response, protocols and programs
2. Compile core project documents that are created such as mission, vision, policies, procedures, etc.
3. Assess alignment of documents such as policies and procedures to best-practices
4. Discuss alignment with the community document conversations and decisions about suggested changes.
5. Document the obstacles to designing projects in community.

Objective 2

Community-driven evaluation plan for monitoring project progress towards goals and outcomes is developed.

Action Steps

1. Assist with the design of logic models that articulate project goals, resources, activities, and outcomes.
2. Work with agencies to establish data collection systems and strategies to document project performance.
3. Work with agencies to build capacity in using and reviewing their administrative data to document program development, inform project activities, and identify program gaps.

Project Implementation: Demonstration sites are aware of their implementation progress and are provided meaningful feedback including preliminary outcomes, strengths, and areas for improvement to better align with identified policies, practices, and programming.

Objective 1

A feedback loop between Illinois HEALS staff and SOC and MDT members to align project implementation to best practices is established.

Action Steps

1. Document implementation progress, including attendance at meetings, strengths and obstacles, and strategies used to overcome.
2. Provide TA on data collection, interpretation, and analysis.
Assess fidelity of project to the policies and programming the community designs through
3. exploring administrative data and conducting focus groups and interviews.
Provide community with information about implementation progress and strategies they may
4. use to address barriers or realign activities to better achieve program fidelity and preliminary outcomes.

Objective 2

Project progress towards achieving preliminary outcomes are assessed.

Action Steps

1. Analyze administrative data and conduct focus groups and interviews to explore the impact of the project.

GOAL 6

Improve the statewide response to victimization of children and youth by raising awareness of the impact of victimization and influencing the policies and practices of agencies and organizations that work with children, youth, and their families.

Raising Awareness: Professionals and the public are aware of the impact of victimization on children and youth and how to respond to victimization.

Objective 1

Regional and statewide multi-agency groups, coalitions, and conferences are identified and engaged in order for Illinois HEALS and ICJIA to share information learned in the project and elevate the voices of victims.

Action Steps

1. Conduct outreach through strategic partners and members of the Leadership Network group to identify opportunities to share information and ideas.
2. Create a variety of presentations and materials that include research findings and information about responses to victimization that can be used with various audiences.
3. Convene the Leadership Network annually to share progress on demonstration site.
4. Create and distribute a quarterly newsletter that highlights progress and lessons learned from the Illinois HEALS project.

Sustainable Initiatives: Communities have the tools to improve their response to child and youth victims of crime.

Objective 1

A toolkit that equips communities to improve the recognition of victimization, the connection of victims to resources, and the engagement of victims and their families in services is created.

Action Steps

1. Analyze data gathered during the Planning Phase.
2. Document the process and outcomes of the work with the Demonstration Site Community.
3. Create fact sheets, templates, and other materials that can be used by communities to conduct needs assessment, network/system building, training, and service capacity-building activities.

ENDNOTES

1. Illinois is one of four states designated as a demonstration site.
2. We acknowledge that the term victim does not resonate with everyone who has experienced violence. Some prefer the term survivor or person impacted by violence. We encourage people and communities to use terms that best reflect their experiences. Throughout this document we use the terms children and youth and young persons to refer to individuals from birth to 25 years of age.
3. For reading ease, throughout this document we use the term family or family members to refer to the adults and other individuals who may live with and/or provide primary care for children and youth. These individuals or adults may include biological relatives (e.g., siblings, adults/uncles, grandparents, parents) and other caregivers (e.g., foster families, other non-relative adults).
4. Office for Victims of Crime (2016). *Linking systems of care for children and youth: Guiding principles*. Available at: https://www.ncjfcj.org/sites/default/files/LSC_Guiding_Principles_Pages_Final.pdf.
5. Office for Victims of Crime (2016). *Linking systems of care for children and youth: Guiding principles*. Available at: https://www.ncjfcj.org/sites/default/files/LSC_Guiding_Principles_Pages_Final.pdf.
6. Office for Victims of Crime (2016). *Linking systems of care for children and youth: Guiding principles*. Available at: https://www.ncjfcj.org/sites/default/files/LSC_Guiding_Principles_Pages_Final.pdf.
7. Finkelhor, D. Poly-Victimization: *Protecting children and their development* [PowerPoint slides]. Presented at the April 2018 Leadership Network meeting of the Illinois Helping Everyone Access Linked Systems.
8. National Child Traumatic Stress Network (n.d.). *Complex trauma: Effects*. Available at: <https://www.nctsn.org/what-is-child-trauma/trauma-types/complex-trauma/effects>
9. Illinois Department of Children and Family Services (2018). *Executive statistical summary*. Available at: <https://www2.illinois.gov/dcf/aboutus/newsandreports/Documents/ExecStat.pdf>.
10. Child Advocacy Centers of Illinois (2018). Retrieved from: <https://www.childrensadvocacycentersofillinois.org/learn/illinois-statistics>.
11. Illinois Criminal Justice Information Authority analysis of Illinois State Police 2017 Uniform Crime Report data.
12. Illinois Criminal Justice Information Authority analysis of Illinois State Police 2017 Uniform Crime Report, Supplemental Domestic Offenses data.
13. Data on specific types of victimization children and youth are exposed to in Illinois are limited. Data collected through the Illinois Uniform Crime Report program entails police agencies reporting aggregate crime data to the State Police on a monthly or quarterly basis. The aggregate data are not reported in a manner that would allow for analysis by victim age or other characteristics. Thus, while we recognize that not all of these incidents involved children and youth direct or indirect victimization, they do illustrate the extent to which violent crime is occurring in Illinois.
14. Center for Disease Control. (2017). *Youth risky behaviors survey*. Retrieved from <https://www.cdc.gov/healthyyouth/data/yrbs/results.htm>.
15. Office for Victims of Crime. (2012). *Child abuse and neglect*. Office for Victims of Crime Training and Technical Assistance Center's website: https://www.ovcttac.gov/downloads/views/TrainingMaterials/NVAA/Documents_NVAA2011/ResourcePapers/Color_Child%20Abuse%20Resource%20paper%202012_final%20-%20508c_9_13_2012.pdf.
16. Finkelhor, D., and Hashima, P. (2001). The victimization of children & youth: A comprehensive overview. In S.O. White (Ed.), *Law and Social Science Perspectives on Youth and Justice*, 49-78.
17. Finkelhor, D., Turner, H., Shattuck, A., & Hamby, S. (2015). Prevalence of childhood exposure to violence, crime, and abuse. *JAMA Pediatrics*, 169(8), 746-754.
18. Alaggia, R. (2004). Many ways of telling: Expanding conceptualizations of child sexual abuse disclosure. *Child Abuse & Neglect* 28(11):1213-1227; Alaggia, R. (2010). An ecological analysis of child sexual abuse disclosure: Considerations for child and adolescent mental health. *Journal of the Canadian Academy of*

ENDNOTES

- Child and Adolescent Psychiatry* 19(1):32–39.
19. Cecil, C. A., Viding, E., Barker, E. D., Guiney, J., & McCrory, E. J. (2014). Double disadvantage: The influence of childhood maltreatment and community violence exposure on adolescent mental health. *Journal of Child Psychology and Psychiatry*, 55(7), 839–848. DOI 10.1111/jcpp.12213
20. Connolly, J., & Gordon, R. (2015). Co-victims of homicide: A systematic review of the literature. *Trauma, Violence, & Abuse*, 16, 494–505.
21. Aeffect, Inc. (2017). 2016 Victim Needs Assessment. Chicago, IL: Illinois Criminal Justice Information Authority. Retrieved from <http://www.icjia.state.il.us>; Elliott, D., Cellarius, K., & Horn, T. (2013). *2012 Oregon Crime Victims' Needs Assessment: Final Report*. Salem, OR: Oregon Department of Justice Crime Victims' Services Division; Lowry, S., Reid, L., Feeley, L., Johnson, M., & Williamson, E. (2015). *Massachusetts Office for Victim Assistance 2014 Needs Assessment*. Massachusetts Office for Victim Assistance. Retrieved from <http://www.mass.gov/mova/docs/voca/mova-2014-needs-assessment.pdf>; Vasquez, A. L., & Houston-Kolnik, J. (2017). *Victim Need Report: Service Providers' Perspectives on the Needs of Crime Victims and Service Gaps*. Chicago, IL: Illinois Criminal Justice Information Authority. Retrieved from http://www.icjia.state.il.us/assets/articles/ICJIA_Victim_service_provider_Needs.pdf.
22. Boccellari, A. (2017). *Reaching underserved victims of crime*. [PowerPoint slides].
23. Aeffect, Inc. (2017). 2016 Victim Needs Assessment. Chicago, IL: Illinois Criminal Justice Information Authority. Retrieved from <http://www.icjia.state.il.us>; Finkelhor, D. *Poly-Victimization: Protecting children and their development* [PowerPoint slides]. Presented at the April 2018 Leadership Network meeting of the Illinois Helping Everyone Access Linked Systems.
24. DePrince, A. P., Labus, J., Belknap, J., Buckingham, S., & Gover, A. (2012). The impact of community-based outreach on psychological distress and victim safety in women exposed to intimate partner abuse. *Journal of Consulting and Clinical Psychology*, 80(2), 211.
25. Vasquez, A. L., & Houston-Kolnik, J. (2017). *Victim Need Report: Service Providers' Perspectives on the Needs of Crime Victims and Service Gaps*. Chicago, IL: Illinois Criminal Justice Information Authority. Retrieved from http://www.icjia.state.il.us/assets/articles/ICJIA_Victim_service_provider_Needs.pdf.
26. Hook, J. N., Davis, D. E., Owen, J., Worthington Jr, E. L., & Utsey, S. O. (2013). Cultural humility: Measuring openness to culturally diverse clients. *Journal of Counseling Psychology*, 60(3), 353.
27. Elliott, D. E., Bjelajac, P., Fallot, R. D., Markoff, L. S., & Reed, B. G. (2005). Trauma-informed or trauma-denied: principles and implementation of trauma-informed services for women. *Journal of Community Psychology*, 33(4), 461–477.
28. For the purposes of this project, a system of care is a coordinated, multidisciplinary group that works collaboratively to develop cross-system policies and procedures that improve access and quality of services for victims and their families.
29. A multidisciplinary team (MDT) is a group of professionals from different disciplines, such as victim services, law enforcement, and education, that come together to discuss clients and how to best coordinate their care and support.

APPENDICES

APPENDIX A: LEADERSHIP NETWORK

Lisa Betz
Chelsea Biggs
Sean Black
Sara Block
Eddie Bocanegra
Brandy Brixy
Michele Carmichael
Terry Carmichael
Mari Christopherson
Colleen Cicchetti
Jennifer Constantine
Avik Das
Mitchell Davis
Heather Dorsey
Liz Dozier*
Arne Duncan
Andrea Durbin
Noni Gaylord-Harden
Phyllis Glink
Gene Griffin
Meg Helder
Cynthia Hora
Judy Howard
Susan Johnson
Jamilah R. Jor'dan
Cassandra Kisiel
Sally Kolb
Alexandra Lagunas
Leslie Landis
Billie Larkin
Thomas Lemmer
Rebecca Levin
John Maki*
Kim Mangiaracino
Honorable Patricia Martin
Marcia Meis
Conny Moody
Julie Morita
Heidi Mueller
Quinn Rallins
Karrie Rueter
Margie Schaps
Allison Schuck
Mashana Smith

Vickie Smith
Amy Starin
Honorable George Timberlake
Antwan Turpeau
Marlita White
Paula Wolff

*Co-Chair

APPENDIX B: COOK COUNTY JUVENILE JUSTICE MAPS

COOK COUNTY JUVENILE JUSTICE FLOW CHART

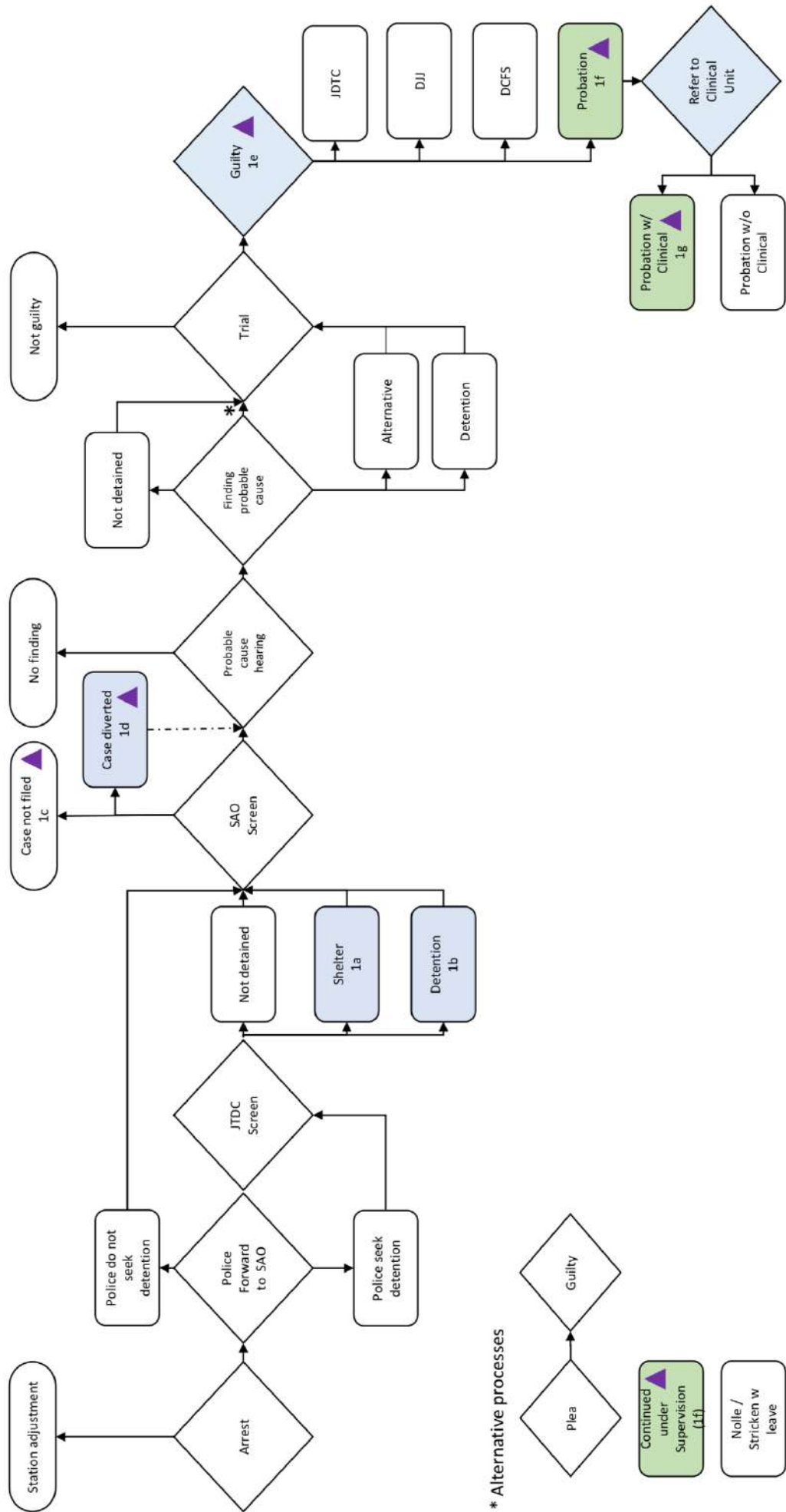

NOTES

1a. & 1b. – Detention screening

- Probation staff conduct the detention screening for JTDC. This screen is specific to whether detention is necessary.
- After a detention hearing the minor may remain in custody or be released upon request

1c – SAO No file

- Currently cases in which the SAO determines that the case cannot be pursued the juvenile and his or her guardian/parent are notified prior to a court hearing. No screening or referral occurs at this time.

1d. – SAO Diversion

- Currently cases in which the SAO determines that the case cannot be pursued the juvenile and his or her guardian/parent are notified prior to a court hearing. No screening or referral occurs at this time.

1e. – Finding of Guilt

- Probation officers conduct a social investigation. Although there is no predetermined set of questions officers must ask, the social history “template” encourages collecting of such information. Individual officers make the decision if, when, and how to ask these questions.
- Youth who are DCFS involved or have a history of DCFS involvement may have additional assessment information that probation officers may request.
- The social investigation is sent to DJJ.

1f. – Post sentencing / Probation (or Continued under Supervision)

- Probation officers will complete a full YASI with youth. There are specific victimization questions on the YASI, but it does not appear that they specifically inform case planning (although they may). Probation officers may request the additional DCFS assessment if applicable.
- Youth may be referred to services as part of their probation. Generally the YASI findings are not shared with the referral agencies. The exception is noted below.

1g. – Referral to Clinical Unit

- Referrals to the Clinical Division are often the probation officer’s discretion and can occur at any time; however there are instances when the judge orders them, based on court observations or review of documents (i.e. social). If referred, additional screening and assessment takes place that may reveal victimization experiences (e.g., CANS). Some of the youth will receive services through the clinical unit, while others may be referred out to one of four agencies, all of which are pay for service agencies: Infant Welfare Society, One Hope United, Constant and Never Ending Improvement (CANE) and Youth Outreach Services (MST). The unit then operates as part of the clinical team to ensure the service agency is following through with services. Additional assessment may occur by referral agencies.

Victimization while on probation

- For probationers who are shot, the CPD notifies juvenile probation staff of youth who have been shot and the staff search to determine if they are on probation.
- Outside of being shot, officers may become aware of victimization while youth are on probation. This may occur during YASI reassessment that should occur every 4 months (it is up to the officer as to whether or not to re-ask the victimization questions – officers can simply “carry over” the information) or upon disclosure by juveniles and/or their families. It is up to the officer if, when, and how to ask follow-up victimization questions.

OPPORTUNITIES AND CONCERNS

Opportunities ▲

- Contact point 1c may represent an opportunity to link youth who have been referred for prosecution but it has been determined by the SAO that the case cannot be pursued. One challenge may be that youth and their families may not follow-up for the referral. The question then becomes whether we could place someone in the SAO that could initiate contact that could later be followed up in the field.
- Contact points 1e, 1f, and 1g were identified as having the potential for creating a consistent screening process by which officers can request information about victimization. These points represent the most time officers spend with youth and their families, which would facilitate the trust needed to disclose sensitive information, such as past and recent victimization experiences.

Concerns

- **Additional screening/assessment work** – Staff willingness to complete additional screening or assessment questions. May be seen as more work.
 - *Suggested solution* – Make sure officers understand why those questions are being asked and have there be a reason for the questions (e.g., link to services, etc.).
- **Youth and family engagement** – It is sometimes challenging to engage youth and their families in services. May want to not discuss or address victimization or the family is facing multiple challenges/issues. Some parental defensiveness may stem from their own victimization/trauma.
 - *Suggested solution* – Engagement seems to work best when you have active outreach to youth and families versus requiring them to come to you. Possibly have services that have already been working with the family successfully engage in this work.
- **Criminalizing youth** – When attending services is part of probation the outcome can be that youth are further criminalized because they don't complete or attend services.
 - *Suggested solution* – (none noted specifically)

Topics for follow-up with other agencies or at future date

- SAO screening process worth discussing with SAO (**DONE**)
- Learn more about JISC/police process (**DONE**)
- Creating referral process outside of justice system to deal with youth diverted
- Youth initially placed in shelter due to the incident being a domestic and the family later decides not to press charges—those kids/families may benefit from services but may drop off the radar because the family declines prosecution.
- Follow-up needed on the SAO diversion cases as the SAO indicate that probation monitors those youth.
- Follow-up needed with victim witness/advocates within the SAO.

CHICAGO POLICE DEPARTMENT FLOW CHART - JUVENILE PROCESSING

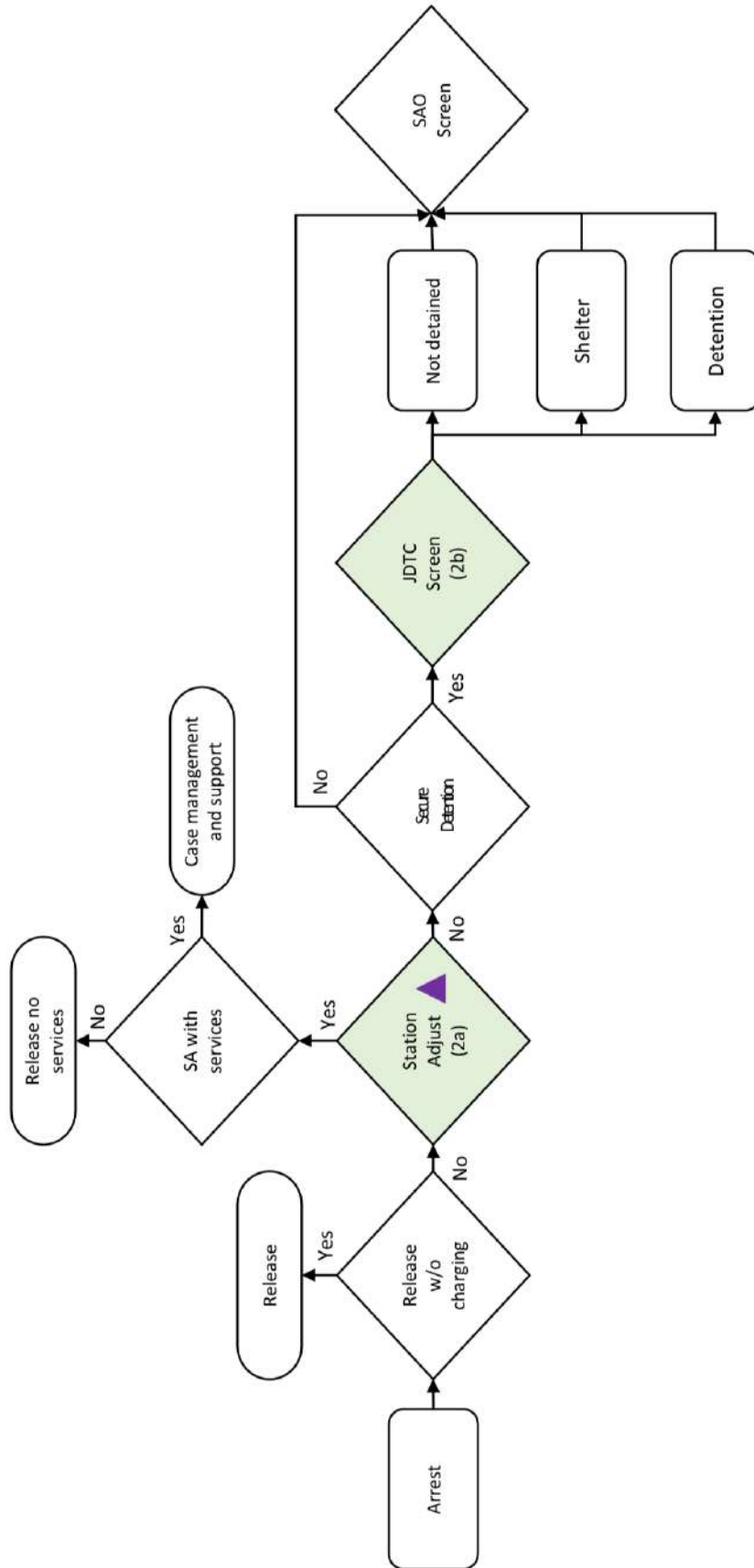

NOTES

2a – Station adjustment type

- If a youth investigator determines that the arrest should result in a station adjustment the youth investigator must then decide whether a formal station adjustment with conditions (such as services) is warranted. Currently, a short screening instrument assists youth investigators in making this decision. The screening instrument is primarily based on current charge, past history, and admission of guilt.

2b – Detention screening

- If the youth investigator determines secure detention is needed, s/he contacts probation, who conducts the detention screening for JTDC. This screen is specific to whether detention is necessary and includes current charge, past history, and mitigating and aggravating factors.

OPPORTUNITIES AND CONCERNS

Opportunities

- Currently past missing and victimization data are not part of the 2a screening process. However, an opportunity might exist to expand the screening criteria to include prior incidents in which the youth had been reported missing or a reported crime victim. Such information could also be shared with the service agencies who engage the youth and their families in case management and support.

CHICAGO POLICE DEPARTMENT FLOW CHART - MISSING/FOUND YOUTH

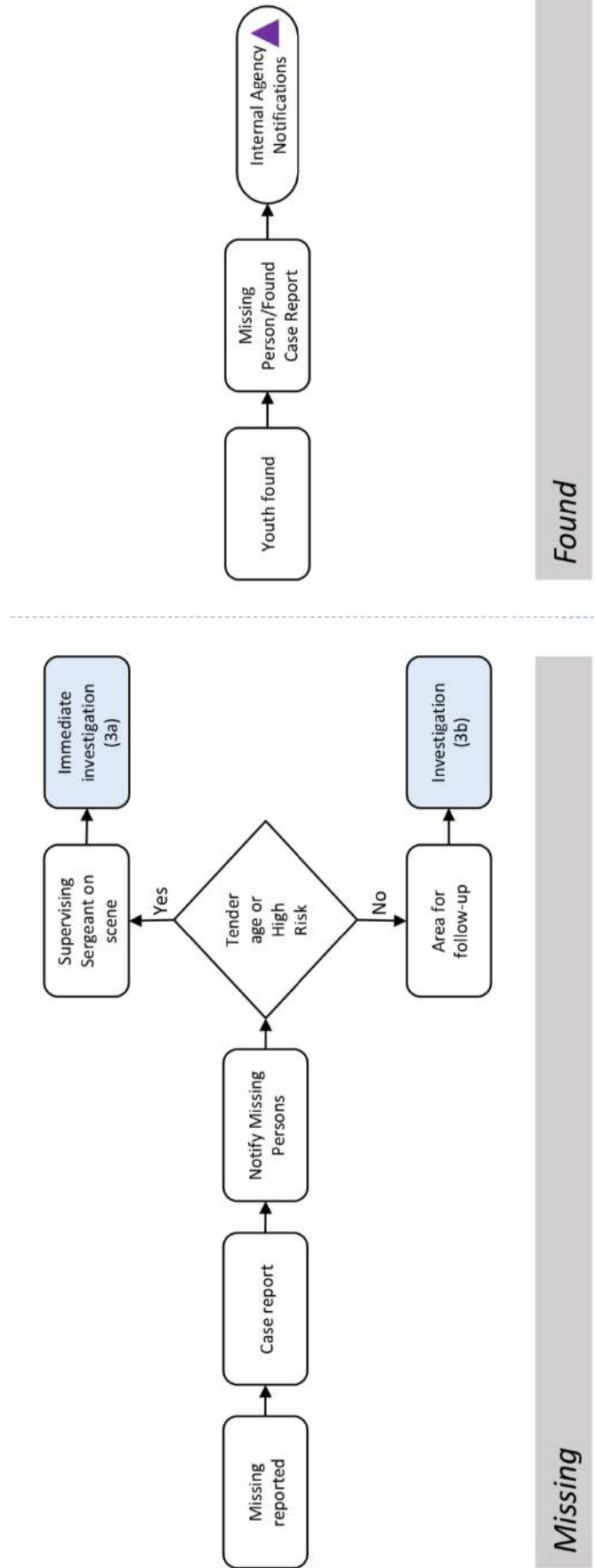

Missing

Found

NOTES

Human Trafficking

- Officers working within Vice may learn about human trafficking in different ways. These include participating in task forces, conducting recovery missions, conducting reverse stings, responding to community complaints about prostitution,
- In some instances, officers will use a co-responding model in which staff from STOP IT, Salvation Army will accompany officers and engage HT survivors in an attempt to get them into services.
- Generally, when the incident involves a youth from out of state, the process involves contacting the police in that jurisdiction and the parent/guardian of that youth. In most cases, the parent/guardian seeks to bring back the youth to the state of origin. Although these cases happen, they do not represent the majority of cases.
- The majority of cases (estimated at 90%) involve youth from around the Chicago-land area or other Illinois community. In these cases, they will attempt to find some type of service referral or temporary placement (emergency shelter). Challenges exist as it relates to (a) engaging youth and families in services, (b) availability of services to address this particularly vulnerable population (Anne's House – emergency/transitional shelter care, for instance, no longer exists).

3a & 3b – Missing investigation

- During the process of a missing investigation detectives may ask the family about prior victimization history or other at-risk behavior that may lead to victimization. No specific set of questions are required; it is up to the discretion of the investigator to obtain from the family or search CPD databases for this information.
- 3b - In a notable portion of cases the youth is found prior to investigators having significant contact with the family. In such a case, the family notifies the police department and the investigation ends.

OPPORTUNITIES AND CONCERNS

Opportunities ▲

- Although the police investigation ends once a youth has been reported found, there may be an opportunity for those youth identified as having multiple missing episodes and/or their families to be referred to support services. There is currently no specific resource investigators can refer to, although some may provide families with a list of resources.

CHICAGO POLICE DEPARTMENT FLOW CHART - CHILD ABUSE/NEGLECT

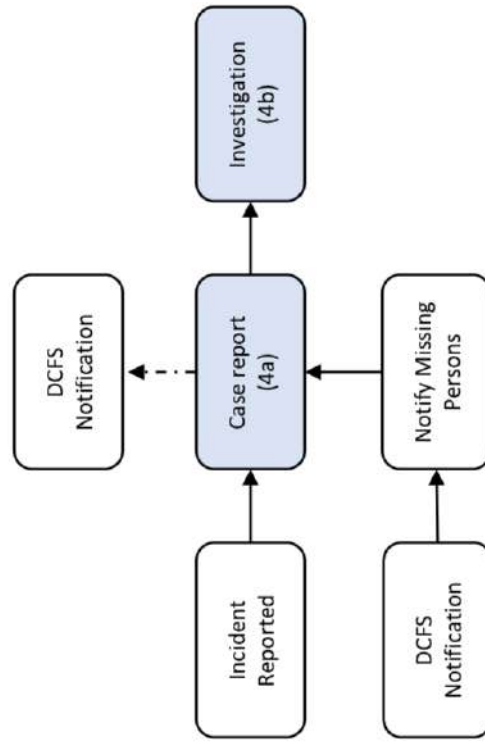

NOTES

4a & 4b – Child abuse case reporting and investigation

- During the process of an investigation officers and detectives learn about victimization of child/youth and possibly other family needs. In cases of suspected child abuse, DCFS has been notified or is the source of the notification. They are conducting their own investigation and linking the child/youth and families to services as deemed appropriate.
- Some cases may be referred to the Chicago CAC. Such cases may include instances of severe abuse or when a forensic interview is deemed appropriate. The CAC may provide additional services to the children, youth, and family as needed (DCFS is on site).

Topics for follow-up with other agencies or at future date

- Follow-up with DCFS on their end of the process and how children, youth, and families are linked to services.

CHICAGO POLICE DEPARTMENT FLOW CHART - SEXUAL ABUSE/ASSAULT

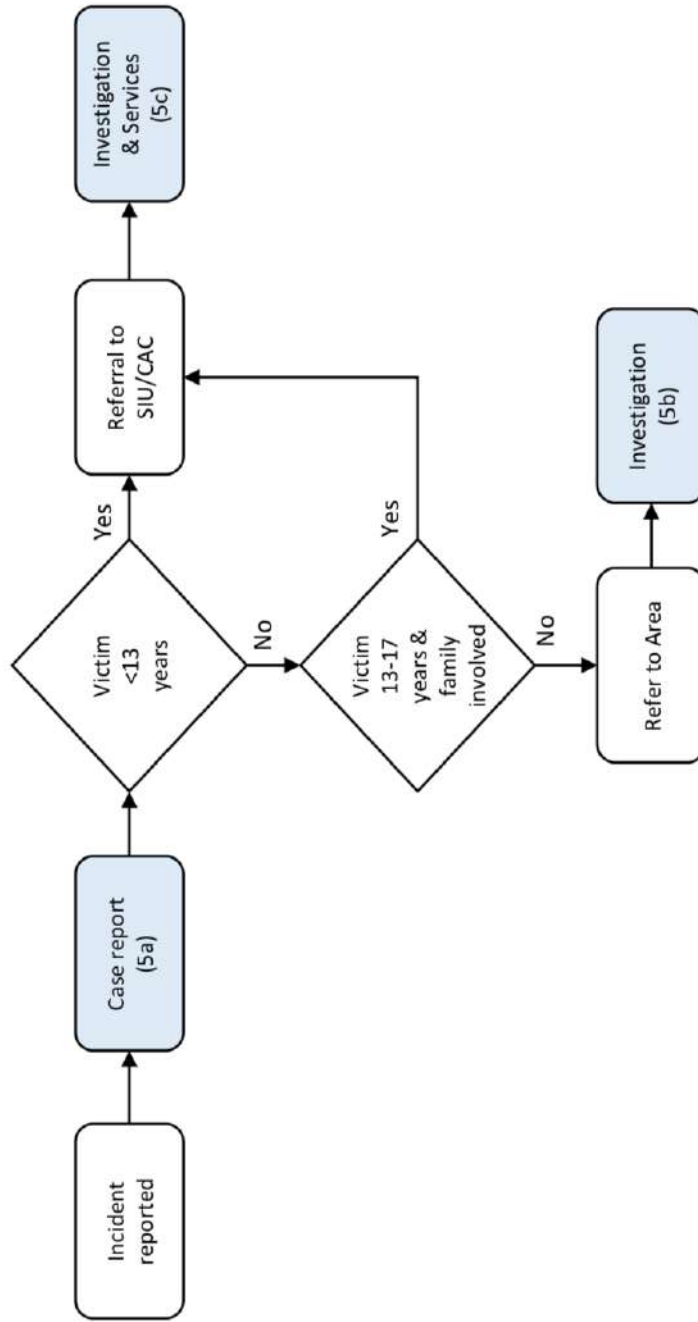

NOTES

5a & 5b – Child sexual abuse case reporting and investigation

- During the process of an investigation officers and detectives learn about victimization of child/youth and possibly other family needs. Investigators and/or detectives provide the victim with the standard victim notification materials and may also refer them to additional resources. Sexual assault victims may also gain access to rape victim advocates while at the hospital.

5c – Child sexual abuse handled through the Chicago Child Advocacy Center

- Cases involving children under 13 years of age or 17 year and young whose alleged perpetrator is a family member will be handled by the Special Investigations Unit located at the Chicago CAC. Children, youth, and families can access services through the CAC.

OPPORTUNITIES AND CONCERNS

Concern

- The Chicago CAC is currently under-resourced and lacks the capacity to serve the children, youth, and families it sees.

CHICAGO POLICE DEPARTMENT FLOW CHART - DOMESTIC VIOLENCE INCIDENTS

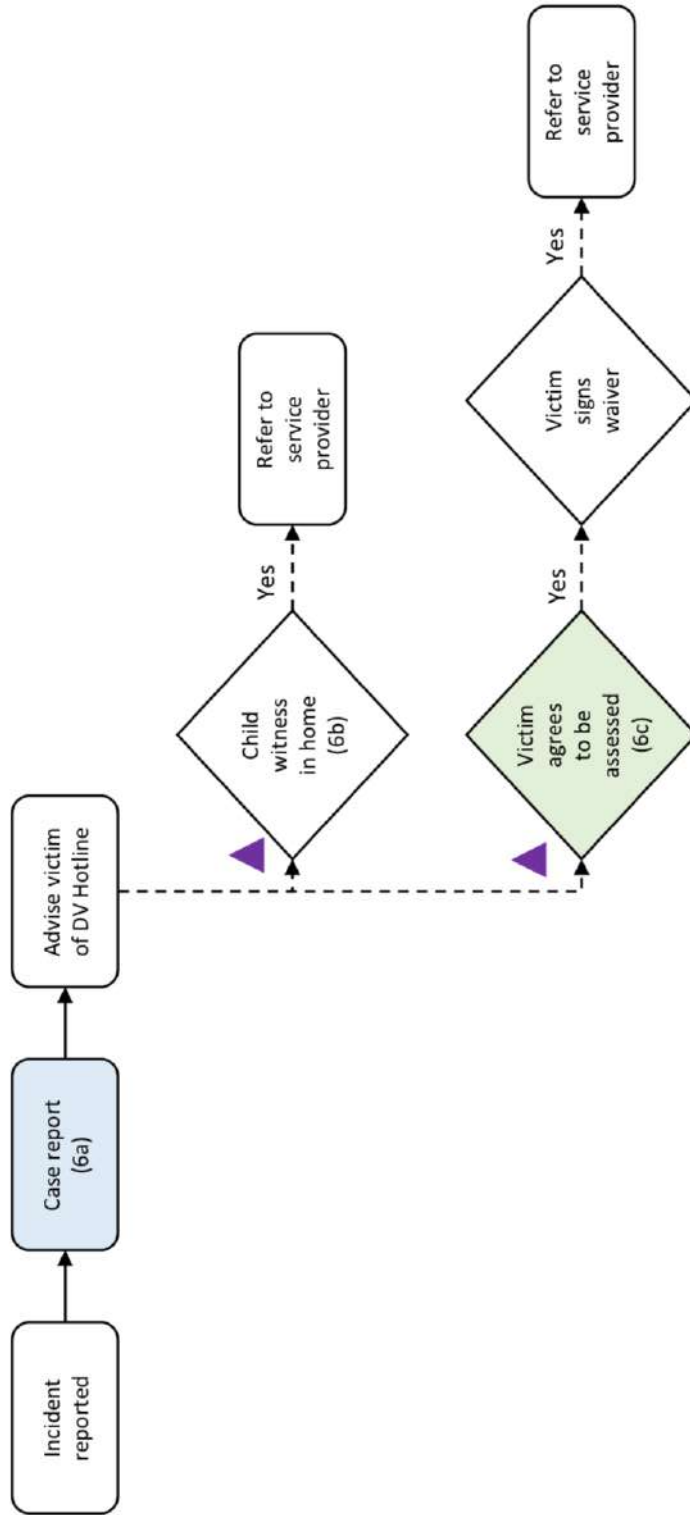

NOTES

6a – DV preliminary investigation

- During the investigation, officers may learn about dv victimization as well as whether there are children exposed to dv in the home. Officers provide victims with the DV Hotline number as standard protocol (Domestic Incident Notice).

6b – Child witnesses – referral option

- Officers have the option of making a referral to an external agency if it is believed that children living in the home are witnessing domestic violence. The extent to which this is occurring is unknown

6c – Domestic Violence Threat Assessment Pilot Program

- Officers in Districts 003, 004, and 014 may have access to a tablet that can be used to conduct a threat assessment. Victims must consent to the assessment and sign a waiver in order for the information to be shared with service providers. If victims agree, the assessment information is sent to a predetermined service provider for follow-up.

OPPORTUNITIES AND CONCERNS

Opportunities ▲

- Expand the current Domestic Violence Assessment Program beyond the current pilot districts.
- Reconnect or strengthen the referral process from the PD to Safe from the Start sites.

Concerns

- The Department has historically struggled with scaling up pilot projects. Funding, purchasing equipment, and staff resources are two factors.
- Safe from the Start sites are state funded. Recent budgetary problems at the state level has impacted the capacity and available and has created uncertainty around whether this resource will continue to exist. It has weakened the referral process as officers may not be fully aware the programs have restarted.

COOK COUNTY SUBURBAN POLICE AGENCIES JUVENILE PROCESSING

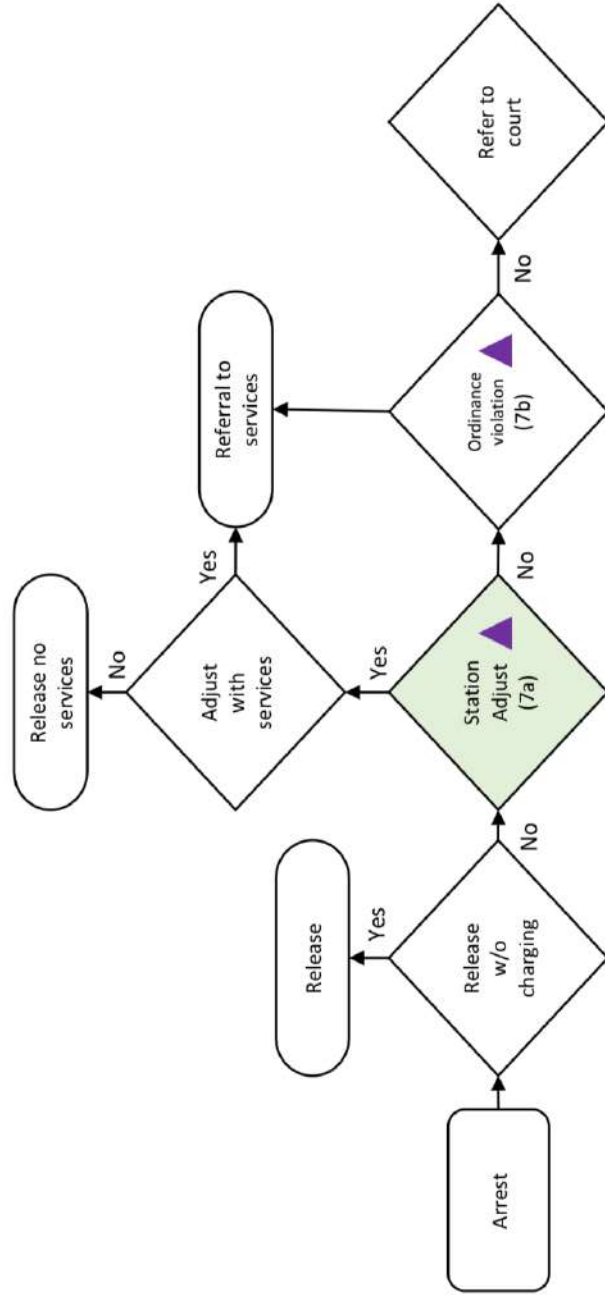

NOTES

7a – Station adjustment type

- If a juvenile officer determines that the arrest should result in a station adjustment the officer can decide whether to refer to services, some of which may be handled internally or externally. Generally, the decision to station adjustment is left to the officer, although the following factors may be considered: age of the juvenile (younger youth— those <10 years— cannot be given ordinance violations), severity of the offense, criminal history, and home situation.
- Park Forest PD recently implemented a trauma screen that all juvenile officers employ. The screen has 10 questions and was based on ACEs. Includes specific questions on victimization history. The screening also provides a response matrix to assist officers in decision making. The screen is based on youth self-report and officers are trained by the Urban Youth Trauma Center to administer the screening questions. The training entails a 4 hour training coupled with a 4 hour booster session. Preferred officers are trained as juvenile officers and have completed CIT training. Referral agency includes Aunt Martha's.

7b – Ordinance violations

- If the juvenile officer determines that a station adjustment is not appropriate, he or she may ticket the juvenile for an ordinance violation. Offenses are misdemeanors and may include assault and battery and theft. An ordinance violation would require the youth to attend a administrative hearing/court. If the violation is upheld, the juvenile may be required to complete community service (most common) or be referred to services.

OPPORTUNITIES AND CONCERNS

Opportunities ▲

- Park Forest PD has already implemented a brief screen for victimization, including a response matrix associated with the screen. The process they used might be something other police agencies can implement. Park Forest PD has also created a Youth Violence Engagement Prevention program. The program is 16 hours. Youth who come into contact with the agency may be referred to the program.
- There is also potentially the opportunity for the screen to be conducted with those kids who receive an ordinance violation and increase availability of services through that process.

Concerns

- Challenges getting youth involved in services when referred. Transportation, parent/guardian willingness, and insurance/cost of services are all issues that will need to be addressed.

Topics for follow-up with other agencies or at future date

- Follow-up with Park Forest PD and the Urban Youth Trauma Center. The screening instrument may be something for other police agencies to consider. We will need to outline a draft implementation plan should this be a space for further development. Follow-up questions regarding if the screen follows the youth? Does the provider know why they were referred?
- The Juvenile Justice Council is working on developing a list of resources and the development of restorative justice options. This may be an additional area of opportunity to consider. Follow-up with the JJC is needed.
- Work with participants to identify potential service providers they currently use.

COOK COUNTY SUBURBAN POLICE AGENCIES MISSING/FOUND YOUTH

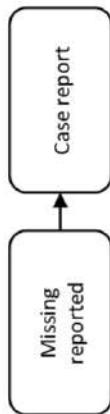

Missing



Found

OPPORTUNITIES AND CONCERNS

Opportunities ▲

- Although the police investigation ends once a youth has been found, there may be an opportunity for those youth identified as having multiple missing episodes and/or their families to be referred to support services. The screen used by the Park Forest PD actually began in response to chronic runaway youth.

Concerns

- A distinction was made between chronic runaway youth and youth who go missing. Some of the defining features include youth who decide to leave on their own accord, are involved in others who might be grooming them for prostitution, etc., or are in foster care or are DCFS wards who continually leave DCFS-funded facilities. These youth are a source of frustration for police agencies who must continually field calls about these youth but are not sure how to address it effectively.
- Another issue brought to our attention were concerned related to sexting. Discussed was how police agencies are trying to deal with youth who may engage in sexually explicit behaviors and share that information electronically with others. The desire is to get youth to understand the consequences of these behaviors, while ensuring what may be adolescent behavior does not result in court involvement.

COOK COUNTY SUBURBAN POLICE AGENCIES MISSING/FOUND YOUTH

Intake - Facility



Aftercare

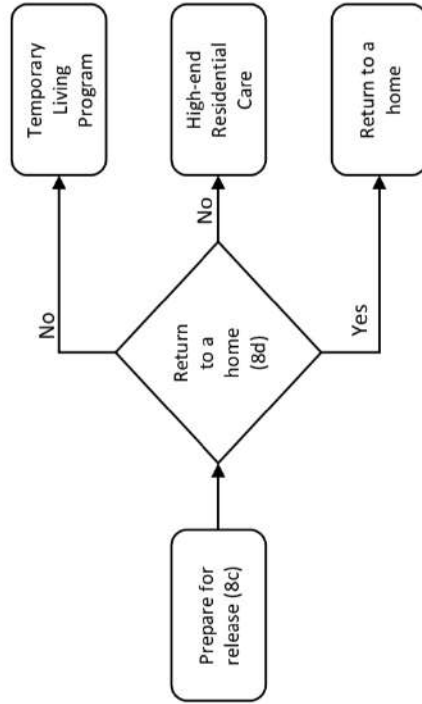

NOTES

8a – Intake screening

- Juveniles enter the facility with a social history completed by the committing county court. Victimization experiences may be noted in the social history. · In addition to the social history, all youth receive a set of screenings/assessments conducted by DJJ staff. These include those that document risk and protective factors (YASI), Risk for sexual victimization, bio-psychosocial needs (GAIN), classification tool, suicide (MAYSI-Massachusetts Youth Screening Instrument), trauma (STRESS-Structured Trauma-related Experiences and Symptoms Screener, a PTSD screening tool which will be implemented by IDJJ later in 2018). Victimization experiences are noted in the YASI and may be disclosed during other screening/assessments. The YASI full assessment gets completed within 30 days of intake and then reassessment is done at 90 days.

8b – Assign facility, Youth and Family Specialist (YFS), treatment team

- Following intake and classification, which occurs at three locations—Warrenville (female), St. Charles, and Harrisburg—youth are assigned a facility, YFS, and a treatment team. The treatment team consists of the following staff: YFS, Juvenile Justice Specialist (security), mental health/substance abuse treatment, education, aftercare liaison, youth, DCFS, and possibly the parent. The treatment team works to develop a case management plan for the youth across the appropriate domains based on the youth's needs (e.g., education, mental health, etc.). Victimization may be disclosed during treatment or other times while the youth is in the facility.
- Some youth may be placed in a High-end residential care, which has more specific services.
- Youth may also experience victimization within the facility. This includes bullying, extortion, assault, battery. In these cases, the facility will work to ensure safety of the youth within the facility. An internal investigation may refer information to the YFS.

8c – Prepare for release

- An Aftercare Specialist is assigned to each youth within a few days of admission. Typically this will be a Specialist who is covering the IYC. The youth will be transferred to the Specialist who will supervise them in the community 3-4 months prior to their Target Release Date. Since 2017, DJJ sets the conditions of release and the Prison Review Board oversees revocation hearings.
- A determination will be made whether the youth has a place to return to or if some other placement is necessary. Older youth (17-19 years) who do not have a place to return to may be placed in a Transitional Living Program, which is similar to a halfway house/group home. This type of placement is unstructured and does not have a lot of clinical services. Some youth may also be placed in a high-end residential care if they have particular needs. This type of place is more structured.

8d – Return to a home (or alternative)

- Once in the community, youth may receive additional clinical services, mental health care, see a therapist, etc. Connections to these services is often predicated on the aftercare specialist and the youth support system. The transition of treatment within the facility to aftercare is not always occurring.

OPPORTUNITIES AND CONCERNS

Opportunities ▲

- Enhance existing services within the facilities to address victimization that occurred prior to entry into the facility and while in custody. There may also be an opportunity to think about what a trauma-informed facility may look like.

Concerns

- Accessing services in the community can be limited due to issues around payment, availability of services, waitlists, engagement practices, and cultural competency of existing services.
- The Transitional Living Programs as whole do not seem to produce positive results. While some youth succeed in these settings, many abscond or bounce from residence to residence. No good alternative exists as other options, such as temporary foster care.

APPENDIX C: MEETINGS THEMATIC ANALYSIS

Paola Baldo

PURPOSE

In January 2018, the Illinois Helping Everyone Access Linked Systems (Illinois HEALS) initiative convened meetings with programs, agencies, and individuals in Illinois, with a focus on agencies and organizations serving Cook County and the southeastern region of the state. The meetings were held to understand processes of programs and agencies serving children, youth, and families in Illinois who have been impacted by victimization, including how young victims are identified and linked to services.

Meeting notes were collected to inform the Illinois HEALS initiative. The research team conducted thematic analysis to build connections between individual meetings to illuminate emerging themes and reveal underlying patterns. The process allowed for a systematic examination of needs, strengths, barriers, and opportunities stakeholders and practitioners encountered when providing services and collaborating with other agencies to meet victims' needs.

METHOD

Procedure

Research staff reviewed Illinois HEALS staff's calendars to identify meetings related to Illinois HEALS to include in the review. Meetings selected for review included those with key stakeholders from different domains that focused on program processes in identifying victimization and signs of underlying trauma, challenges and barriers to service delivery, and nature and scope of program referral and collaboration networks. Program and research staff were instructed to create detailed summaries of meeting discussions, including attendance, meeting purposes and goals, and main ideas shared.

A total of 48 meetings held between January 1, 2018 and October 17, 2018 were identified for inclusion in the analysis. Staff notes were available for 29 of the meetings. January 1, 2018 served as the commencement date for project activities. October 17, 2018 was chosen as the most appropriate end date for collection of meeting notes because subsequent meetings were beginning to narrow focus into specific communities in Illinois.

A central repository folder for typed or photocopied meeting notes was created in a shared drive. Handwritten or photocopied notes were typed to make them easier to access, code, and analyze. The research team received approval from ICJIA Institutional Review Board (IRB) to conduct a secondary data analysis of all written notes generated from Illinois HEALS meetings.

Analytic Strategy

The meeting notes and transcripts were imported into Nvivo 12 Plus, a qualitative data analysis software. Using this software, an open coding process of the meeting notes was initiated wherein data was parsed into smaller parts and assigned codes or a word or phrase that may best describe its underlying concept or phenomenon. This method allowed researchers to gain a greater understanding of issues covered during the meetings by uncovering similar points of discussion.

Through this exploratory process of open coding, preliminary topics were found to be consistent with the emerging themes identified throughout the planning phase of the project. Illinois HEALS's *Recognize, Engage, and Connect* framework guided the coding structure for subsequent phases of data analysis.

Recognize: Learning that a child, youth, and/or family member has experienced recent or past victimization, including exposure to violence.

Connect: Linking a victim to services or system providers to meet their needs, such as healthcare, advocacy, and safety, following victimization.

Engage: Providing services, such as medical care, counseling, and legal assistance, to victims to meet their needs following victimization.

Researchers used this framework to complete a form of structural coding where our initial codes were organized based on their congruence to the three overarching themes above.

FINDINGS

Recognize

Learning about victimization occurs in different ways by different people. Providers sometimes become aware of clients' victimization experiences through informal means, such as during casual conversations with clients; however, this information may not always lead to a referral or connection to resources. Nevertheless, these informal ways of learning about victimization allude to the importance of trusting relationships between providers and clients. Providers shared that young persons do not always feel comfortable revealing deeply personal experiences at the onset of their entry into services.

Providers feel ill-prepared to engage young persons about victimization. Providers reported that they feel ill-prepared to engage young persons about victimization. In general, they noted a need for more training to build overall capacity in recognizing signs indicative of victimization and trauma. They also acknowledged how their training needs are impacted by workforce turnover. Although agencies and programs offer trainings and education on several trauma-related issues, high levels of turnover require agencies to continually hire and train new employees. This constant shift in the workplace not only contributes to a relatively inexperienced staff, but has mitigating effects on staff's ability to build trusting relationships with clients. New employees who acquire outgoing employees' cases need to reestablish rapport and trust with clients who may be reluctant to keep retelling their experiences.

Some providers have sought training on approaches to dealing with children and youth who might have trauma histories. Because of the complex nature of trauma and its varied manifestations, it may be challenging to approach young persons in appropriate and meaningful ways without potentially retraumatizing them. For instance, providers acknowledged that youth with disabilities, youth with individualized education programs (IEP), or homeless youth are likely to have histories of abuse and some providers felt ill-prepared to address these issues appropriately without causing additional harm.

Building capacity to recognize victimization. Providers expressed an array of barriers and challenges to identifying past or recent victimization experiences of clients. These often resulted in missed opportunities to recognize harm has occurred and may require a connection to services. Providers agreed that early recognition and intervention are key to preventing further harm and promoting the healing of victims and families. While some form of screening or intake process is common, such as among medical providers, the tools used often do not include specific questions about experiences of victimization. Given the complexity of the intake and screening processes in hospitals, clinics, and other

medical facilities, medical providers, in particular, worry that adding another dimension will further complicate the process and place a heavier burden on staff and their clients.

Mandated reporting is not always the answer. Providers who are also mandated reporters expressed their reluctance to report suspicions of abuse or neglect because doing so may result in negative consequences for both the child and the reporter. In some cases, reports might trigger an investigation that could result in increased risk of harm for the child. Providers worry that children being abused in the home may experience further abuse because of an investigation or may be taken out of the home and placed into another abusive living situation. Some providers also suggested that making a report may result in the loss of rapport or trust with the child who shared his or her experiences; therefore, making the child unwilling to disclose further.

Providers also noted that inadequate training around mandated reporting contributes to misinformation about obligations to report as well as the general process of reporting. For instance, one misconception is that evidence of physical harm or a pattern of abuse is needed before a report can be made; this misconception may lead to underreporting. In settings that have additional internal policies and procedures in place related to mandated reporting, such as in schools, internal processes tend to slow or inhibit reporting to the Department of Children and Family Services (DCFS). These policies might result in internal investigations wherein school administrators or staff assume the task of fact-finding prior to making a formal report.

Connect

Lack of available and accessible services for positive screens. One of the most common concerns was an overall lack of resources available to children, youth, and families impacted by violence. In the southeastern region of the state, for instance, agencies and programs have service areas that span several counties, which may mean victims need to travel to other counties in order to access resources. Several agency and program representatives reported program shutdowns as a result of financial crises created by the Illinois budget impasses in 2016 and 2017, placing additional strains on existing agencies to meet the needs of clients.

While some general services exist, they are not always sufficient for clients who may have unique treatment needs. Providers also expressed the need for specialized services, such as partial-hospitalization programs, trauma therapies, and transitional programming for young adults. Additionally, because specialized services are already few and far between, clients often must travel long distances to receive them, which providers identified as one of the reasons clients can no longer engage in services.

Furthermore, because of this lack of services, integrated health providers shared their concerns over ethical issues posed by a positive identification without subsequent referrals to resources. They questioned the appropriateness of screening for services that they are unable to provide or find resources that can adequately address victim needs. This also may have a negative impact on building rapport and trust with clients who disclose their victimization experiences without receiving the support they need.

Lack of information sharing. Providers shared their frustrations around the lack of technology to effectively track availability and accessibility of client services. Some providers found it challenging to continually track current information regarding service availability, further inhibiting meaningful connections between clients and resources. In cases where providers are familiar with the existence of programs, they may still be unaware of the specific types of services offered by programs, who the programs serve, or whether they have capacity for new clients.

Also limited is information sharing within and across systems on whether referrals resulted in clients engaging in services. Providers expressed their need for improved communications with partner agencies, especially when follow-up with clients or another referral is needed. Sometimes, the impetus to connect with a referral is placed on the client; however, there are few existing mechanisms that can confirm these connections with the referring agency. Lack of guidance around what types of information can be shared can further impede meaningful connections between victims and resources.

Threshold for services. Providers noted challenges in connecting clients with services when their symptoms or needs do not rise to a level that necessitates extensive treatment or meets the criteria for formal diagnosis. Unfortunately, in these instances, some treatments are not covered by insurance without a formal diagnosis and providers find the issue difficult to navigate. Providing a formal diagnosis may allow a client to access care, but doing so also poses ethical dilemmas for providers who recognize the need for some services, but not the need for a formal diagnosis.

Engage

Systems in Illinois are overtaxed and under-resourced. The 2016-2017 budget impasse in Illinois resulted in a loss of funding for many providers, forcing some to close their doors. The resulting decrease in available services placed the burden on staff in the remaining agencies whose employees may already be experiencing the strain of demanding caseloads. Organizations throughout the state have reported experiencing high levels of employee turnover and difficulties in recruiting highly qualified staff. This results in a relatively inexperienced workforce. Although new employees undergo some training, they are left dealing with increasingly complex cases for which they may be unprepared.

Stakeholders indicated many of the systems that regularly engage children and youth are operating at or over capacity. Many engage in crisis management, adopting a triage approach to services. In Cook County, for instance, Comprehensive Community Based Youth Services (CCBYS) providers observed a shift in practice where more cases of crisis youth were taken on at the expense of non-crisis cases. Because these providers were using most of their resources to support youth in crisis, they were unable to extend their services for long-term care. This triage approach results in prioritizing certain cases and leaving others unaddressed. Some organizations who have tried to navigate this issue believe that peer or paraprofessionals could help relieve overburdened staff by undertaking some tasks and responsibilities to free up specialized staff to address more complex victim needs.

Importance of relationships. A trusting relationship between providers and clients is an important foundation for meaningful engagement in services; however, agencies and programs with high rates of turnover find it challenging to build rapport and trust with their clients who might have to retell their stories every time they seek help from a new provider.

To strengthen client relationships, providers recommended actively engaging victims and their families in every step of their service plans. Allowing clients to be the drivers ultimately empowers them and may result in more meaningful participation that promotes better outcomes. Especially in cases where clients are involved in a number of different services from a number of different providers, giving clients the power to direct their service plan can increase their accountability and motivation to succeed.

Challenges for children, youth, and families. Providers noted several barriers and challenges their clients face when seeking help or participating in services. One of the biggest barriers, they said, is the lack of transportation to get clients to and from services. The issue is especially problematic in rural areas where there is no public transit system and services are few and far between.

In addition, the typical hours of operation for agencies and programs often conflict with the availabilities of their clients. Service participation during the day can be difficult, with client school and work conflicts. Scheduling also is challenging for families who are engaged in several services, often requiring prioritization of programming.

Engaging clients in services when basic needs, such as food, employment, and safety are unmet also is difficult. Providers said client poverty issues were pervasive and that juggling their clients' multiple treatment needs while attending to their other basic needs was a challenge.

Familial and multigenerational approaches. Providers have recognized that violence and victimization affect not only the victim, but the whole family; therefore, services that treat the whole family unit are sorely needed. However, due to funding constraints, lack of qualified staff, and other challenges, providers find it difficult to serve entire families. Providers shared that they refer families to partner agencies and other programs, but that places the burden on the family to coordinate their own care and navigate different providers.

Fatigue, stress, and vicarious trauma. Providers throughout the state are recognizing the strain experienced by staff associated with high caseloads, limited resources, and exposure to their clients' own experiences of trauma. Caring for and providing treatment to children, youth, and families who have been impacted by violence can have negative impacts on the well-being of staff and may contribute to stress, burnout, and turnover. While some organizations are trying to implement practices aimed at supporting the health and well-being of staff, such as regular supervision and promoting self-care, some practices are reactionary in nature, implemented only after staff report or exhibit unmanageable levels of stress. Furthermore, self-care is not often prioritized by staff. For many providers, especially those with demanding caseloads, supporting clients supersedes the need to regulate their own well-being.

Providers recommended that regular staff supervision can foster relationships and keep supervisors informed when staff is experiencing unmanageable levels of stress that could lead to burnout. Adequate support for staff also positively impacts the quality of care they provide to their clients.

IMPLICATIONS AND RECOMMENDATIONS

Increase the capacity of all professionals who have contact with children and youth to recognize signs of trauma. Organizations who serve children and youth should train staff to recognize verbal, non-verbal, behavioral, and other cues that signify trauma resulting from past or current victimization. This includes not only direct service providers, but also in spaces where interactions between adults and young persons naturally occur.

Schools can serve as a neutral and consistent touchpoint where administrators and staff are in a unique position to learn about experiences of harm by fostering trusting relationships with students. Increasing the capacity of all school personnel to recognize trauma also increases the number of potential individuals who can identify students in need for service connection. One of the potential challenges to capacity-building within school systems, however, is that while teachers typically have the most contact with students, they may already be experiencing strain resulting from increased responsibilities; therefore, training all other school personnel (e.g. coaches, bus drivers, or lunchroom monitors) will decrease the burden on teachers to be the sole steward of students.

Furthermore, the school system may be one of the most easily accessible places for children and youth to connect to services. It may be ideal in school settings to co-locate direct service providers who may be better equipped to respond to the needs of children and youth identified by school personnel.

Broaden screening and assessment practices. A lack of specific questions related to victimization experiences in screening and assessment tools may result in a missed opportunity to recognize and connect someone who might need services and support. Screening and assessment practices should be broadened to include questions related to victimization. For instance, in cases where individuals are not ready to disclose their experiences, a direct question is unlikely to prompt a disclosure.

More information is needed to understand and identify who is the most appropriate person or role to administer formalized screening and assessment protocols. Differences in victimization experiences, complexity of needs, or organizational context can impact whom a victim feels comfortable disclosing to during screening and assessment. Identifying the most appropriate person to conduct this screening may be challenging because whom a client trusts may differ based on their relationships and histories.

Foster partnerships and collaborations among organizations. Building and fostering collaborative relationships among organizations can alleviate some of the barriers and challenges to providing services, such as lack of information sharing. Meaningful collaboration, however, extends beyond simply coming together to exchange information. Rather, it includes active problem solving to break down siloed approaches to service provision, collectively informing and establishing best practices, and improving responses to children, youth, and families who are impacted by trauma. Collaborations between systems can help establish shared language, definitions, understanding, and approaches related to victimization. This might include determining clarifying who is eligible for victim services, establishing trauma-informed practices to addressing victimization and trauma, and strategies to implementing evidence-based programs.

Explore strategies that reduce staff burden and support their health and well-being. Strategies that can help reduce staff burden and increase capacity to meet client needs should be explored. One such strategy providers discussed was hiring peer professionals or paraprofessionals. Peer or paraprofessionals are individuals from the community who are not formally trained but have shared experiences and can take on some tasks and responsibilities that allow formal system professionals to focus on specialized services. Peer professionals can also bridge the gap between organizations and the larger community by mobilizing individuals who can bolster the presence of organizations and building trusting relationships with the community. Not only can this increase awareness of available services, but it may help alleviate the stigma associated with seeking or receiving services. Additionally, peer or paraprofessionals who have direct interactions with community members, such as violence interrupters or family resource developers, can engage children and youth who would not or could not otherwise seek services on their own. Although this may sound like a promising strategy, more research is needed to fully assess and evaluate the impact of peer and paraprofessionals.

The negative impacts of fatigue, stress, and vicarious trauma signals the need for organizations to not only prioritize, but institutionalize policies and procedures that foster a safe occupational climate. Prioritizing the health and well-being of staff may lead to a healthier work environment where staff can learn to recognize their needs and identify the resources that can support them. Organizations are encouraged to develop creative preventative measures, such as creating space for staff to regularly decompress, debrief, and reflect. Furthermore, early recognition of unmanageable levels of fatigue, stress, and trauma can prompt staff to get the support they need to reverse or mitigate the associated negative impacts. Institutionalizing these practices can help shift organizational culture into one that is more mindful and supportive of the needs of those who serve people with traumatic experiences.

CONCLUSION

Providers in Illinois are continually seeking opportunities to expand and improve services that are available to children, youth, and families impacted by trauma. Many are finding unique ways to navigate the challenges posed by the increasingly complex needs of victims that are further exacerbated by larger contextual factors such as state budget issues and disparate systems of care. Supporting existing programs and helping them build capacity to recognize victimization, connect to services, and engage meaningfully with clients can alleviate the burden on families to find the support that they need.

APPENDIX D: DIRECT SERVICE PROVIDER SURVEYS

Amanda L. Vasquez

PURPOSE

The direct service provider survey was conducted to inform an Office for Victims of Crime demonstration initiative, Linking Systems of Care for Children and Youth, in Illinois. This initiative, referred to as Illinois Helping Everyone Access Linked Systems (Illinois HEALS) is a statewide effort seeking to improve how organizations and agencies in the state respond to children, youth, and families impacted by violence. The survey was administered during the project's planning phase to better understand how agencies and programs serving children, youth, and families in Illinois learn about client victimization and exposure to violence, services available to victims, and referral and collaboration processes. The results will guide next steps during implementation of demonstration sites in different communities in Illinois.

METHOD

Procedure

Illinois HEALS program staff emailed invitations to take the survey to agencies and programs providing advocacy, healthcare, and legal assistance services to children, youth, and families in Illinois; staff knowledge of programming in the state coupled with research to identify additional providers was used to generate the list of invited participants. Emails were sent to program or agency directors through the online survey's email distribution utility. While this function is useful, agencies and programs may have been less likely to open the email with the survey invitation or to have the email reach their inbox because the email did not originate from Illinois HEALS staff, negatively impacting survey participation.

The email invited directors to participate in the survey and encouraged them to forward the survey invitation to their networks and listservs to reach additional service providers. Agencies were instructed to select one representative (i.e., program director, coordinator, supervisor, or manager) to complete the survey. Staff inferred the agency and program representatives could most accurately answer survey questions; other staff with different agency roles may have been able to more accurately answer certain questions. Agencies with two or more unique programs serving children, youth, and adults had the option to complete a survey for each program. Two follow-up emails were sent to remind the invited participants to complete the survey.

Survey respondents were asked about the services they provide to children, youth, and families, how they learn about client victimization and exposure to violence, referral and collaboration processes, and general agency or program information, including catchment areas and staffing.

ICJIA researchers received IRB approval to conduct a secondary data analysis of the survey responses.

Sample

A total of 184 unique agencies and programs serving children, youth, and families in Illinois participated in the direct service provider survey. Most agencies or programs reported serving Cook county (42 percent), followed by Central (39 percent), Northern (25 percent), and Southern Illinois regions (23 percent), and the Collar counties (21 percent).[i] Respondents largely described their agencies or programs as either victim service- (37 percent) or social service-focused (33 percent). Fewer categorized their agencies/programs as child welfare (7 percent), civil or family court (4 percent), education (4

percent), healthcare (5 percent), or juvenile justice based (3 percent). The remaining 7 percent of respondents did not indicate a category. Many agencies and programs in Illinois did not complete a survey; few child welfare, civil or family court, education, healthcare, and juvenile justice service providers participated in the study. Thus, findings presented here are most indicative of victim service and social service agencies and programs in Illinois and are not generalizable.

Analysis

Researchers conducted a secondary data analysis. Descriptive analyses were utilized to examine the data. Frequencies were obtained for categorical variables.

FINDINGS

Descriptive analyses of the direct service provider survey data were organized around three distinct and interconnected components to victim service delivery:

Recognize: Learning that a child, youth, and/or family member has experienced recent or past victimization, including exposure to violence.

Connect: Linking a victim to services or system providers to meet their needs, such as healthcare, advocacy, and safety, following victimization.

Engage: Providing services, such as medical care, counseling, and legal assistance, to victims to meet their needs following victimization.

Recognize

Agencies and programs were asked whether they routinely asked about the victimization experiences of their clients and the clients' family members. Most reported doing so (Figure 1). Victimization experiences included clients' recent victimization, including direct violence, abuse, or neglect experienced in the past year, victimization history (i.e., victimization occurring more than a year ago), and exposure to violence, including seeing or hearing violence.

Providers were less likely to routinely ask about direct victimization experienced by their clients' family members during their lifetimes, including immediate family, such as caregivers or parents, siblings, and children, and extended family, such as grandparents and other relatives (Figure 1).

Figure 1. Percentage of Surveyed Agencies and Programs Who Ask About Client and Family Member Victimization, by Victimization History Type ($n = 184$).

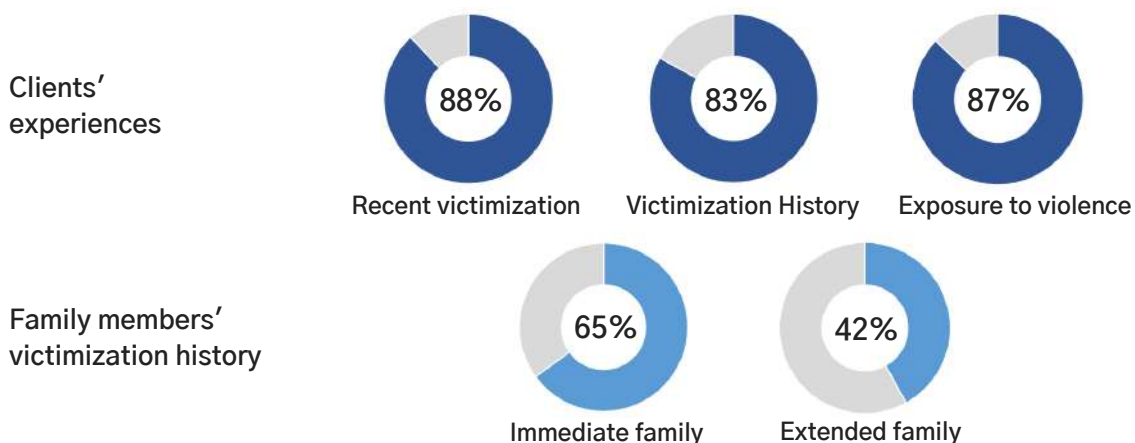

Agencies and programs were asked how they learn about the victimization experiences of clients and their family members. Providers reported learning about victimization through screening tools, referral sources, such as other programs or agencies, intake questions, and assessment tools. Screenings tools were described as brief sets of questions for identifying victimization and/or exposure to violence. Assessment tools refer to formalized and validated questionnaires for measuring behaviors or symptoms consistent with victimization. Most providers reported using intake questions to learn about their clients' and clients' family members' victimization experiences (Figure 2). Most providers learned of victimization through assessment and referral sources.

Figure 2. Percentage of Surveyed Agencies and Programs Using Different Approaches to Learn About Victimization, by Victimization History Type (n = 77 to 161).[ii]

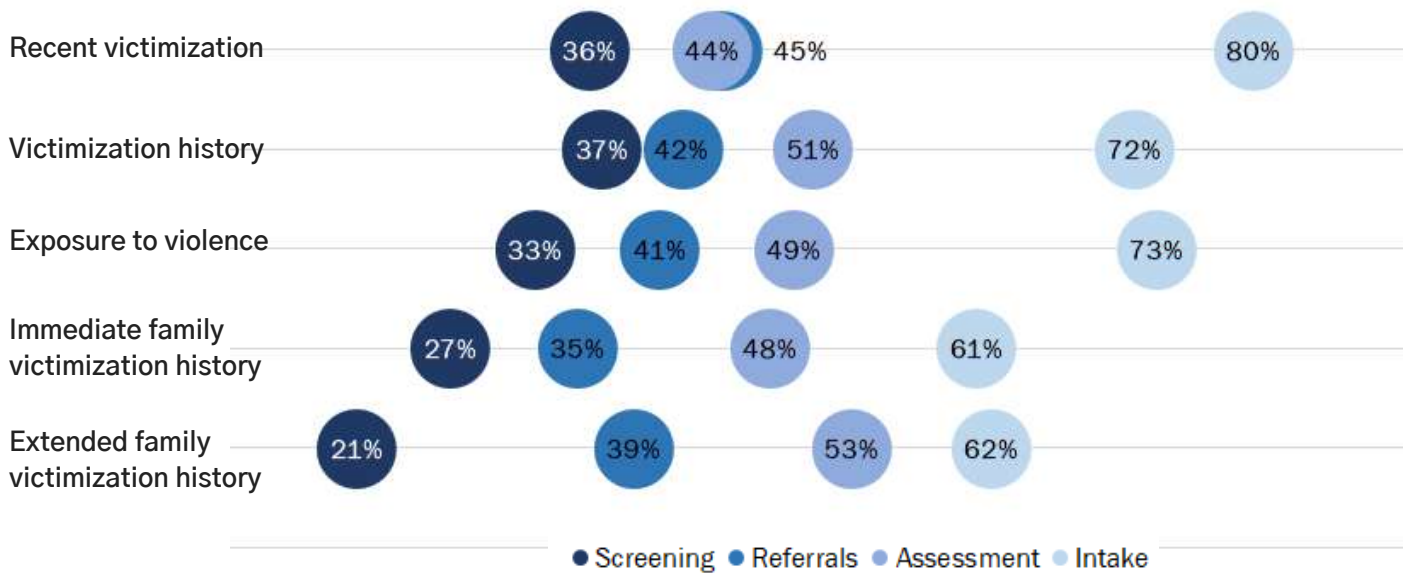

The screening and assessment tools used by agencies and programs to document victimization varied greatly. Providers reported using over 25 different tools, most commonly the Adverse Childhood Experiences (ACEs) Questionnaire and Youth Assessment and Screening Instrument (YASI). Providers also reported using tools developed internally to screen or assess clients.

Further analyses suggest providers may be unfamiliar with the distinct purposes of screening and assessment tools. Screening is intended to assist providers in deciding whether to assess a client for services through the identification of specific problems, such as victimization, whereas assessments are designed to obtain more detailed information about a client's symptoms and needs to aid in developing a service plan.[iii] Some providers indicated they use an agency-created assessment tool to screen for victimization. Others reported using screening tools, such as the ACEs Questionnaire, a set of 10 items for identifying childhood abuse, neglect, and other potential stressors[iv] and the Trauma Symptom Checklist for Children (TSCC), a screening tool for identifying symptoms resulting from trauma,[v] as victimization for assessment. Neither the ACEs Questionnaire nor the TSCC elicit the comprehensive client information need to inform client service plans.

Connect

Agencies and programs were also asked to report how often they meet with other providers to improve cross-agency or cross-system relationships through referral networks or learning collaboratives. Referral networks meet to review and discuss programming, whereas learning collaboratives are comprised of small groups of professionals who learn and practice specific approaches and/or clinical interventions together. Most providers met as part of a referral network or learning collaborative either monthly or

quarterly (Figure 3), with referral network meetings occurring more often than learning collaborative meetings.

Figure 3. Collaboration Types and Frequencies Reported by Surveyed Agencies and Programs (n = 184). [vi]

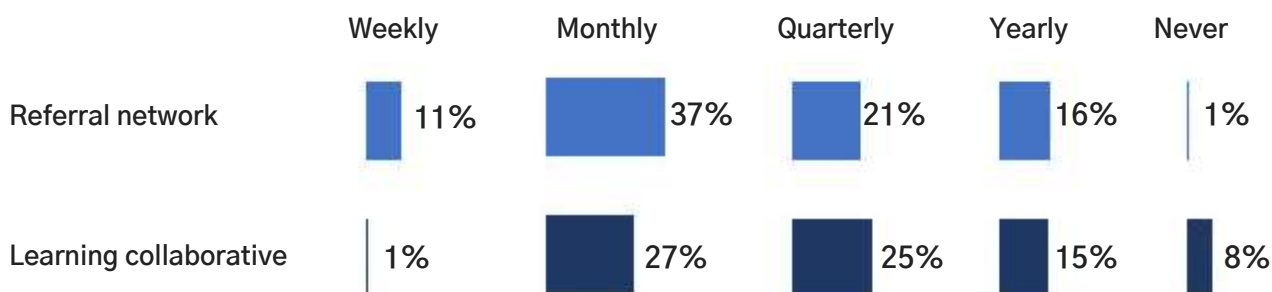

Providers also were asked how often their agencies or programs met as part of a multidisciplinary team (MDT) in which groups of professionals from different disciplines, such as victim services, law enforcement, and education, come together to discuss clients and how to best coordinate their care and support. Agencies and programs indicated the frequency with which they participated in **intra**-agency MDT meetings, held with representatives from within their own agency or program, and/or **inter**-agency MDT meetings, with representatives from within their own agency or program and with other organizations. Most agencies or programs reported having **intra**-agency MDT meetings either weekly or monthly, whereas most reported meeting as part of an **inter**-agency either monthly or quarterly (Figure 4).

Figure 4. Multi-Disciplinary Meeting Frequencies Reported by Surveyed Agencies and Programs (n = 184).[vii]

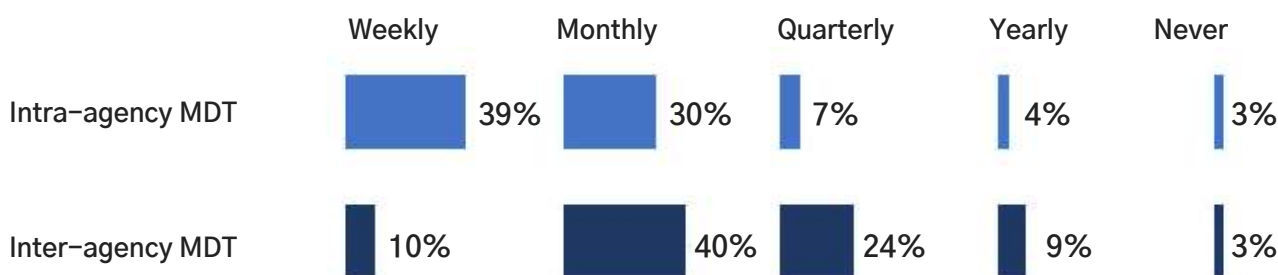

Given that a primary goal of the survey was to better understand how young victims and families are connected to services, referrals between victim service providers and child welfare, civil or family court, education, healthcare, juvenile justice, social services, and other victim service providers also were examined. These analyses revealed that more victim service agencies or programs reported receiving referrals from child welfare than any other type of provider with nearly nine in 10 victim service providers receiving referrals from child welfare providers (Figure 5). The fewest victim service agencies and programs reported receiving referrals from civil or family court providers or the juvenile justice system. Approximately two-thirds to three-quarters of victim service agencies or programs reported receiving referrals from the remaining providers types, including education, victim services, health, and social services.

Figure 5. Percentage of Surveyed Victim Service Agencies and Programs **Receiving** Referrals, by Provider Type (n = 68)

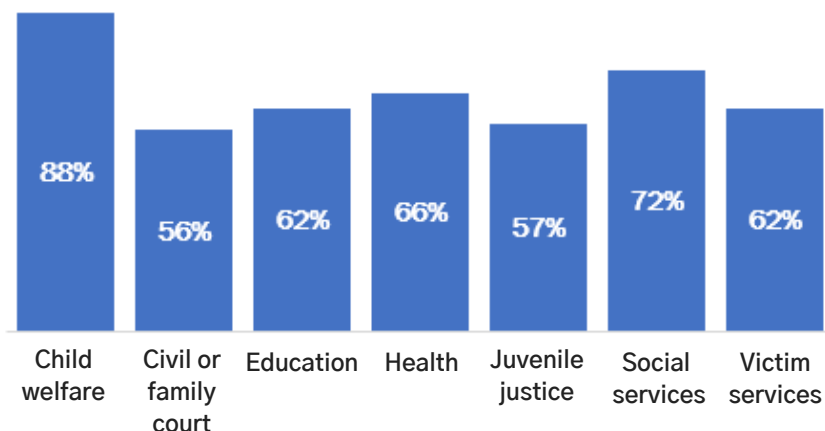

The percentages of victim service agencies and programs that provide referrals to other providers were also examined. These analyses did not include referrals made to education providers and the juvenile justice system because it is not necessarily appropriate for victim service agencies or programs to make referrals for services to these types of providers as they are unlikely to offer services that could provide additional help and support to families impacted by victimization. Victim service agencies and programs reported providing referrals to social service providers more often than to other providers, with over 75 percent of them making these referrals (*Figure 6*). About two-thirds of the respondents reported making referrals to healthcare or other victim service agencies or programs. Fewer victim service providers made referrals to child welfare than any other provider type followed by civil or family court; less than half made referrals to either of these provider types.

Figure 6. Percentage of Surveyed Victim Service Agencies and Programs **Providing** Referrals, by Provider Type (n = 68).

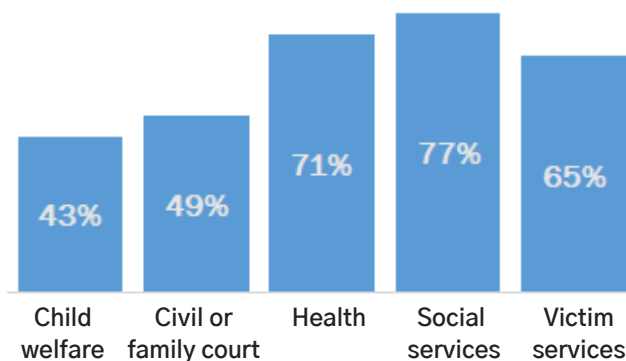

Engage

Providers were asked whether their agencies or programs provided services to meet needs children and families commonly have following victimization. These services include:

- *Advocacy*: Someone to help provide information, referrals, or emotional support.
- *Civil legal assistance*: Help with non-criminal legal issues such as acquiring identification or replacement documents, family, financial, or immigration matters, or orders of protection.
- *Emergency shelter*: A safe place to stay for a short time.
- *Case management*: Help coordinating care to meet the needs of the client or of the client and their family.
- *Group support*: A group of people with similar experiences who meet to offer one another support.
- *Individual counseling*: Someone to talk to about how clients are feeling.
- *Individual therapy*: Someone who is trained, such as a counselor or therapist, to talk with clients about stressful experiences

Agencies and programs reported they were most likely to provide advocacy (90 percent) than any other service, followed by case management (82 percent), and individual counseling services (70 percent). Respondents were least likely to offer emergency shelter (27 percent) or civil legal assistance (32 percent). More than half of the respondents provided group support (57 percent) or individual therapy (55 percent) to clients.

When asked who they provided these services to, providers indicated that, with the exception of civil legal assistance, services were most commonly offered to children (i.e., young persons under 21 years old) than adults (*Figure 7*). Additional analyses revealed fewer providers offered the same service to both children and adults. For instance, while 83 percent of respondents offered advocacy services to children, just 66 percent provided the same service to adults, and only 60 percent of respondents offered the service to both children and adults. A single provider was less likely to offer the same service to both children and adults than to either children or adults.

Figure 7. Percentage of Surveyed Agencies and Programs Offering Services to Children and Adults, by Service Type (*n* = 184).

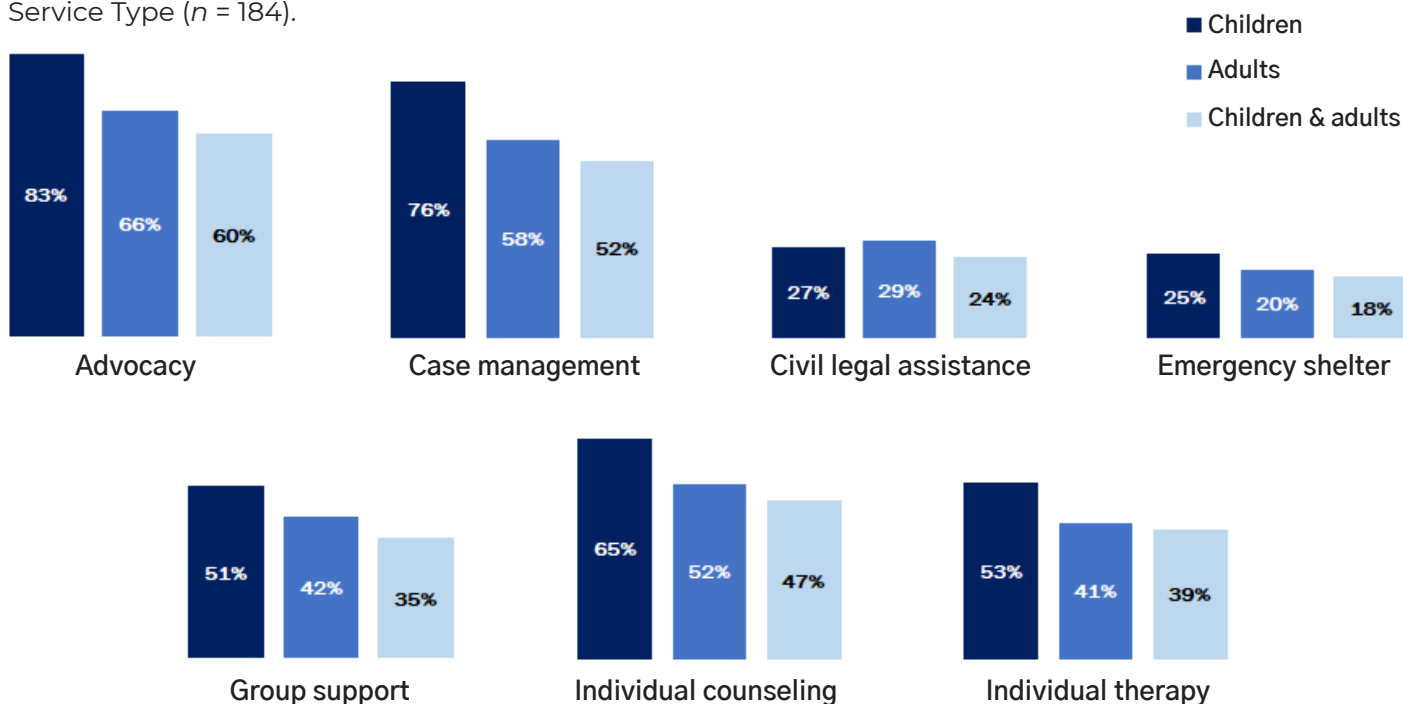

Most respondents reported offering victim-focused advocacy (72 percent), case management (65 percent), and individual counseling services (61 percent). Fewer than half reported offering individual therapy (47 percent) and group support services (44 percent) designed to address victimization. Far fewer providers offered victim-focused civil legal assistance (29 percent) or emergency shelter (21 percent).

Providers also were asked whether they offered victim-focused services to family members, such as parents, children, and siblings. Nearly half of the respondents reported offering victim-focused advocacy and case management services to family members (Figure 8). While more than 25 percent of agencies and programs provided individual counseling, individual therapy, and group support to family members in a way that attended to victimization, fewer had victim-focused civil legal assistance and emergency shelter for family members.

Figure 8. Percentage of Surveyed Agencies and Programs Offering Victim-Focused Services for Family Members, by Service Type (n = 184).

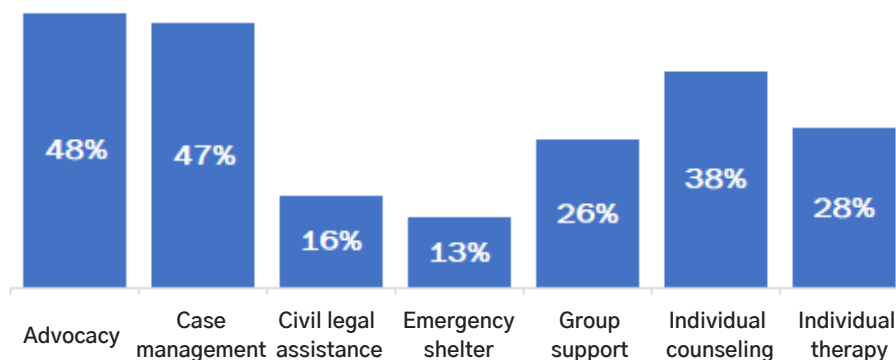

Respondents reported the types of family members they provide victim-focused services to, including siblings, children, custodial parents, foster parents, and non-custodial parents. Fewer than half reported offering victim-focused services to the siblings and children of direct victims of crime (Figure 9). Primary caregivers were even less likely to be offered victim-focused services by respondents, with fewer than half of programs and agencies surveyed reporting they offer these services to custodial parents and even fewer respondents reporting these service offerings to foster parents and non-custodial parents.

Figure 9. Percentage of Surveyed Agencies and Programs Providing Victim-Focused Services to Family Members, by Family Member Type (n = 184).

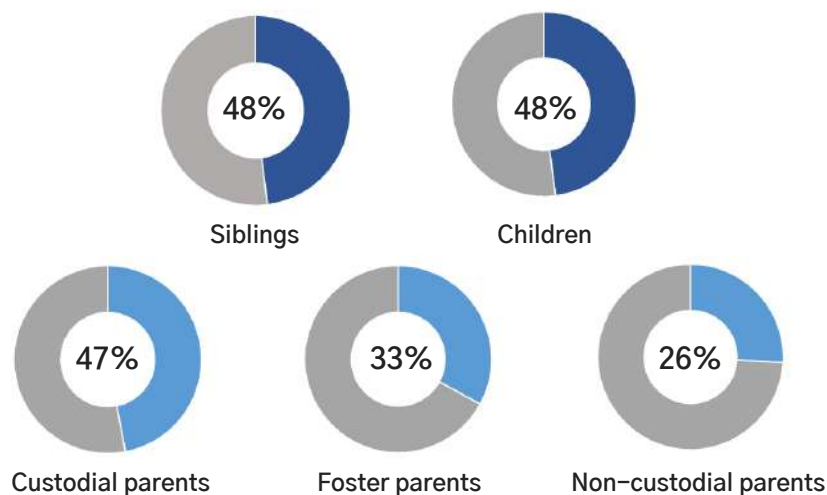

RECOMMENDATIONS

[Learn more about how providers are using different approaches and tools to recognize victimization.](#)

Validated victimization- or trauma-specific screening and assessment tools help service providers accurately identify victimization and victimization-related symptoms and ensure appropriate referrals and service plans. While respondents indicated they are most likely to learn about victimization during intake, they reported using screening and assessment tools created internally. It was unclear whether the intake questions or the agency created screening or assessment tools providers used incorporated elements from validated tools, such as the TSCC. Validated tools have empirical evidence to show they can accurately identify problematic behaviors or posttraumatic stress symptoms that are not easily observable.^[viii] Agencies and programs can benefit from learning more about how other providers are utilizing intake questions and screening and assessment tools to recognize victimization. These benefits include ensuring that providers are using the shared language needed to make meaningful service connects by knowing more about the types of victimization and associated symptoms and/or needs partnering providers or those with similar catchment areas are asking about and the tools utilized.

It is appropriate for victim service and child welfare service providers to use an assessment tool, given their primary focus is to provide services to victims. Education or healthcare providers may not be adequately equipped to address victimization. Therefore, screening for victimization and then connecting clients to victim-focused services may be a more appropriate use of time and resources. This could help to mitigate frustration clients may feel as they undergo repeated assessments with different service providers, some of whom are not equipped to provide needed services. Agencies and programs across different systems should consider working together to identify strategies for ensuring screening and/or assessment is being conducted at the appropriate time and by the appropriate system provider.

[Understand how current information sharing practices within and between agencies and systems both facilitate and inhibit victim and family member connection to and engagement with services.](#)

More than one-third of responding agencies and providers reported learning about a client's victimization through referrals. This suggests some providers are sharing information across agencies and programs, alleviating some of the burden of finding appropriate services and facilitating provider connections. Further exploration of the information sharing processes and practices being employed by these agencies and programs among providers or through researcher-practitioner partnerships may help to inform strategies, including approaches to overcoming barriers, providers can apply to improve how they connect with other providers and how they connect clients to other providers. A working group focused on information sharing is one way providers can learn more about current information sharing practices, opportunities for improvement, and the feasibility of implementing changes.

Nearly half of the responding agencies and programs met with others at least monthly to review and discuss programming through a referral network. In contrast, less than a third of the respondents reported participating in a learning collaborative at least monthly and 8 percent had never attended a learning collaborative meeting. Referral network meetings enable providers to share information about eligibility criteria, service availability, and referral practices to ensure meaningful connections, but learning collaboratives are also important because they offer opportunities for providers to learn about how others are using or adapting promising or evidence-informed practices to engage victims.

Providers also participated more often in intra-agency MDT meetings than in inter-agency MDT meetings. Given victims and families are often unable to have all their needs met by a single agency or program, both intra-agency and inter-agency MDT meetings allow case-level information sharing about clients and an opportunity to strategize collectively on how to best meet their needs. Therefore, providers should examine whether they have the capacity to increase the frequency with which they

participate in learning collaborative and/or inter-agency MDT meetings to better facilitate service connection and engagement.

Improve connections between victim service agencies and systems positioned to play a crucial role in recognizing victimization. The juvenile justice system works with child and youth populations that often have extensive trauma histories with studies estimating that over 90 percent of youth with juvenile justice system involvement have experienced at least one traumatic event and that these youth on average have experienced five different forms of trauma,[ix] yet only about half of victim service providers surveyed reported receiving referrals from juvenile justice agencies or programs. In a national study, researchers found that 61 percent of children from birth to 17 had experienced at least one type of victimization, such as physical assault and witnessing community violence, in the past year. [x] Approximately two-thirds of victim service agencies or programs received referrals from educators and from healthcare providers. Given all educators and healthcare providers have regular and frequent contact with children and youth likely to have experienced victimization, efforts should be made to strengthen services connections between victim service agencies and programs and both the education and healthcare systems. Juvenile justice, education, and healthcare systems have the potential to serve as important partners in recognizing victimization and in making service connections. More information is needed to better understand whether potential barriers, such as lack of victimization screening or eligibility criteria, may be inhibiting linkages and how to strengthen information sharing and service connections between these systems and victim service providers can be strengthened.

Examine the needs of children, youth, and families impacted by victimization and the current capacity of agencies and programs to meet those needs. More agencies and programs reported providing advocacy or case management than civil legal assistance and emergency shelter, but it is unknown if current service levels are sufficient to meet client need and the capacity of providers to expand quality services. Even though most providers indicated offering advocacy and case management services they may be providing those services at or over capacity making it difficult for victims to access these services; there may also be promising or evidence informed practices providers may not have the knowledge or resource to fully implement.[xi] Therefore, it is necessary to conduct further research to better understand not only the needs of children and adult victims, but the availability and capacity of agencies and programs to provide needed, quality services to all service-seeking victims.

Explore the capacity of providers to engage the whole family in services. Research suggests that trauma impacts the entire family unit. Some families may experience the same traumatic events. Other family members may feel stress after learning of another family member's victimization or when interacting with victimized family members exhibiting trauma-related symptoms.[xii] As a result, programs and agencies should strive to understand the victimization histories of the entire family and to make services available to all family members.

The survey data analyzed suggested agencies and programs in Illinois may not be equipped to serve entire families. Agencies and programs are less likely to provide the same services to both adults and children. Additionally, less than half of agencies and programs reported providing victim-focused services to family members. Therefore, families may be unable to access services for the entire family from a single provider. This lack of centrally located services for the entire family may create a barrier to service engagement for families.[xiii] Further follow up is needed to better understand the resources providers need to build provider capacity to engage the whole family in services at one site in a way that attend to the impacts of victimization. Increasing capacity to engage family members in services may also lead to an increase in the number of providers asking about family members' victimization history. The inability to address client victimization directly or through referrals can lead to provider frustration and an approach to service delivery that prioritizes other needs over victimization impacts. [xiv]

CONCLUSION

The Direct Service Provider Survey revealed agencies and programs engage in many practices to recognize, connect, and engage children, youth, and families impacted by violence. Providers reported using different methods to learn about client victimization and share information within and across agencies and systems. It remains unclear, however, whether tools used by agencies to recognize victimization are valid and whether current identification and information sharing practices result in service connections.

Agencies and programs provide many services to children, youth, and families impacted violence, but services are offered at the same location and to all family members are limited. This creates barriers to services that care coordination could alleviate.

The present study emphasized the need to better understand the needs of victims, the availability of services to meet these needs, and how services are coordinated among providers. Additional research to better understand how current approaches to recognizing victimization, connecting victims to services, and engaging them in services facilitate or inhibit the healing of children, youth, and families impacted by violence can improve service delivery and ultimately outcomes for young victims and families.

ENDNOTES

- i. Percentages exceed 100 percent because some agencies or programs reported serving more than region of the state.
- ii. Sample size varied based on the number of agencies and programs that reported asking about client and family member victimization: recent victimization ($n = 161$), victimization history ($n = 152$), exposure to violence ($n = 160$), immediate family member victimization history ($n = 119$), extended family member victimization history ($n = 77$).
- iii. Substance Abuse and Mental Health Services Administration. (2015). *Substance abuse treatment: Addressing the specific needs of women*. Rockville, MD: U.S. Department of Health and Human Services. Retrieved from <https://store.samhsa.gov/system/files/sma15-4426.pdf>
- iv. Centers for Disease Control and Prevention. (2016). *Violence prevention: ACE study*. Retrieved from <https://www.cdc.gov/violenceprevention/acestudy/about.html>
- v. Wevodau, A. (2016). Review of trauma screening tools for children and adolescents. *National Youth Screening & Assessment Partners*. Retrieved from <http://www.nysap.us/Review%20of%20Trauma%20Screening%20Tools%20for%20Children%20&%20Adolescents.pdf>
- vi. Percentages do not total to 100 percent because not all survey participants responded to these survey items.
- vii. Percentages do not total to 100 percent because not all survey participants responded to these survey items.
- viii. Sullivan, G. M. (2011). A primer on the validity of assessment instruments. *Journal of Graduate Medical Education*, 3(2), 119-120. Retrieved from <https://www.ncbi.nlm.nih.gov/pmc/articles/PMC3184912/>
- ix. Pickens, I. B., Siegfried, C. B., Surko, M., & Dierkhising, C. B. (2016). *Victimization and juvenile offending*. Los Angeles, CA: The National Center for Child and Traumatic Stress. Retrieved from https://www.nctsn.org/sites/default/files/resources/victimization_juvenile_offending.pdf
- x. Finkelhor, D., Turner, H., Ormrod, R., Hamby, S., & Kracke, K. (2009). *Children's exposure to violence: A comprehensive national survey*. Washington, D.C.: U.S. Department of Justice. Retrieved from <https://www.ncjrs.gov/pdffiles1/ojdp/227744.pdf>
- xi. Houston-Kolnik, J., & Vasquez, A. L. (2017). *Victim Service Delivery: Illinois Providers' Perspectives on Victim Service Barriers and Agency Capacity*. Chicago, IL: Illinois Criminal Justice Information Authority.
- xii. Collins, K., Connors, K., Davis, S., Donohue, A., Gardner, S., Goldblatt, E., Hayward, A., Kiser, L., & Strieder, F. Thompson, E. (2010). *Understanding the impact of trauma and urban poverty on family systems: Risks, resilience, and interventions*. Baltimore, MD: Family Informed Trauma Treatment Center. http://nctsn.org/nccts/nav.do?pid=ctr_rsched_prod_ar
- xiii. See Houston-Kolnik and Vasquez (2017).
- xiv. Colarossi, L., Breitbart, V., & Betancourt, G. (2010). Barriers to screening for intimate partner violence: A mixed-methods study of providers in family planning clinics. *Perspectives on Sexual and Reproductive Health*, 42(4), 236-243.

APPENDIX E: VICTIM INTERVIEWS

A report outlining key findings from Victim Interviews is currently in development and will be available soon.

APPENDIX F: TIME-TASK PLAN

